

User Guide

PANTUM

WWW.PANTUM.COM

Pantum P2210-P2510 Series Monochrome Laser Printer



It is recommended to carefully read this Guide before using the printer

Preface

Welcome to the Pantum series products!

We heartily appreciate your using of Pantum series products!

To protect your vital interests, please carefully read the following statements.

Legal Notice

Trademark

Pantum and Pantum logos are registered trademarks of Zhuhai Pantum Electronics Co.,Ltd.

Microsoft®, Windows®, Windows Server® and Windows Vista® are trademarks registered by Microsoft Corporation in the United States or other countries/regions.

The ownership to the names of the software in this User Guide belongs to their respective owned companies in accordance with corresponding license agreement, and they are referred for instructions only.

All other product and brand names herein may be the registered trademarks, trademarks or service marks of their respective owners, and they are referred for instructions only.

Copyright

The copyright of this User Guide is owned by Zhuhai Pantum Electronics Co.,Ltd.

It is prohibited to copy, translate, modify and transmit this User Guide by any means or forms without the prior written consent of Zhuhai Pantum Electronics Co.,Ltd.

Version: V1.0

Disclaimer

For a better user experience, Zhuhai Pantum Electronics Co.,Ltd. reserves the right to make changes to the User Guide. The information contained herein is subject to change without notice. Users are responsible for any damages arising from failing to follow this User Guide. Meanwhile, except the express warranty made in the product maintenance manual or service commitment, Zhuhai Pantum Electronics Co.,Ltd. does not make any express or implied warranty or guarantee to this User Guide (including composing or words).

Using this product to copy, print, scan certain documents or images or make other forms of operations may be prohibited by the local laws. If you are uncertain about the legality of using this product for certain documents or images, you should consult your legal advisor in advance.

Safety Precautions

Disconnect the power supply

The product should be placed close to or easily accessible to power sockets, so as to allow easy disconnection of power supply!

Laser Safety

The laser radiation is harmful to the human body. Since laser components are completely sealed in the printer, laser radiation will not leak. To avoid laser radiation, please do not randomly disassemble the printer!

The printer follows the provisions of Class 1 laser products under CFR standard. The printer has a Class III B laser diode, which has no laser radiation leakage among laser components.

The laser components shall comply with the requirements of: U.S. Code of Federal Regulations, 21 CFR 1040, IEC 60825-1

The following label is attached to the laser components inside the printer:



or



Safety Warning

Please note the following safety warnings before using the printer:

Warning



There is a high-voltage electrode inside the printer. Before cleaning the printer, make sure the power is turned off!

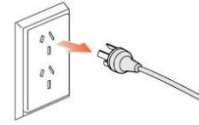

Plugging and unplugging the power cord plug with a wet hand may result in an electric shock.



The fuser unit is hot during and after printing. Touching the fuser unit (the shaded area as shown) may cause burns!

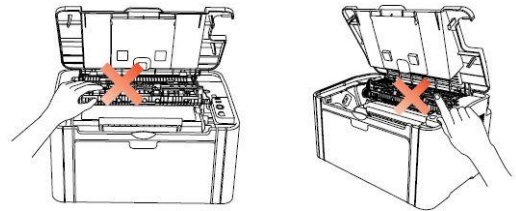

The fuser unit bears a high temperature warning label. Please do not remove or damage this label.

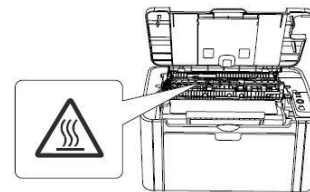

Precautions

Precautions before Using the Printer:

1. Read and understand all instructions;
2. Familiarize yourself with the basic principles associated with operating electrical appliances;
3. Comply with all warnings and instructions marked on the equipment or specified in the manual supplied with the equipment;
4. If the operating instructions conflict with the safety information, please refer back to the safety information, as you may have misunderstood the operating instructions. If you cannot resolve the conflicts, please call the Customer Service Hotline or contact a service representative for help;
5. Before cleaning the equipment, remove the power cord from the AC power supply outlet. Do not use liquid or aerosol cleaners;
6. Please make sure that the equipment is put on a stable desktop surface to avoid serious damage caused by the falling of the equipment;
7. Do not put the equipment near a radiator, an air conditioner, or a ventilation pipe;
8. Do not place any articles on top of the power cord. Do not put the equipment in a place where its power cord will be stepped on by people;
9. Outlets and extension cords must not be overloaded. This may reduce performance and could result in fire or electric shock;
10. Do not allow pets to chew on the AC power cord or the computer interface cable;
11. Do not allow sharp objects piercing equipment slot, so as to avoid contact with the high-voltage device, which otherwise may result in fire or electric shock. Take care not to spill liquids onto the equipment;
12. Do not disassemble the equipment so as to avoid the risk of electric shock. Necessary repairs may only be carried out by professional maintenance personnel. Opening or removing the cover could result in an electric shock or other potential hazards. Incorrect disassembly and assembly could also result in an electric shock during future use;
13. If any one of the following occurs, disconnect the equipment from the computer and pull out the power cord from the AC wall socket and contact a qualified member of the service personnel for maintenance:
 - Liquid has been spilled into the equipment.
 - The equipment has been exposed to rain or water.
 - The equipment falls, or the cover is damaged.
 - Significant changes in the equipment's performance.
14. Only adjust the control mentioned in the instructions. Incorrect adjustment of other controls may result in damage and mean that professional maintenance personnel need to spend more time fixing it;

-
15. Do not use the equipment in a thunderstorm so as to avoid the risk of an electric shock. If possible, pull out the AC power cord during a thunderstorm;
 16. If you continuously print multiple pages, the surface of the tray will become very hot. Take care not to touch this surface, and keep children away from this surface;
 17. The signal wire of the device connected with the printer can not be connected to the outdoors;
 18. Please ensure timely ventilation in case of a prolonged use or printing huge amounts of documents in a poorly ventilated room;
 19. In standby status, the product will automatically enter into the power saving (sleep) mode if it does not receive any job order for a while (such as 1 minute); and it can realize zero power consumption only if it has not been connected with any external input power supply;
 20. As the Class 1 equipment, the product must be connected to the power supply outlet with protective grounding line when using;
 21. This product should be placed according to the shipping marks on the product package box during delivery;
 22. This product is a kind of low-voltage equipment. When using this product below the specified voltage range, please refer to the product precautions or call Pantum Aftersales Service Centre, if the toner comes off the printed contents, or the equipment starts slowly;
 23. This product is sold as a complete machine. The consumers can go to Pantum Aftersales Service Centre to purchase parts they need. If the product sold is inconsistent with the package list, please go to the specified Aftersales Service Centre to solve the problem;
 24. Install this product in a place with the temperature between 10°C to 32.5°C, and the relative humidity between 20% to 80%;
 25. For security and other reasons the printer may switch to intermittent printing after a certain amount of continuous printing.
 26. Please keep this User Guide properly.

Regulatory Information



This symbol indicates that, at the end of your product's life, it must not be discarded as domestic waste. Instead, you should dispose of your used equipment at a designated collection point for the recycling of waste electrical and electronic equipment. Ref: EU Directive 2002/96/EC on Waste Electrical and Electronic Equipment (WEEE). Please contact your distributor / supplier for further information.



This product is suitable for indoor use only.



European Community (EC) directives conformity

This product complies with the protection requirements of EC directives 2014/30/EU and 2014/35/EU on the approximation and harmonization of the laws of the Member States relating to electromagnetic compatibility and safety of electrical equipment designed for use within certain voltage limits.

Radio Equipment directive 2014/53/EU only for models ending with suffix "W".

The manufacturer of this product is: Zhuhai Pantum Electronics Co.,Ltd.,
No.3883,Zhuhai Avenue,Zhuhai,Guangdong,China 519060.

A declaration of conformity to the requirements of the Directives is available upon request from the Authorized Representative.

This product satisfies the Class B limits of EN 55032 / EN 55035 and safety requirements of EN 62368-1.



This printer is fully compliant with the ROHS Directive 2009/95/EC and the requirements of the revised Directive 2011/65/EU for managing toxic and hazardous substances.

Table of Contents

1. Before Using the Printer	1
1.1. Product series introduction.....	1
1.2. Supplied Accessories.....	2
1.3. Product View.....	3
1.4. Laser Toner Cartridge.....	4
1.5. Easily-Refilled Laser Toner Cartridge.....	4
1.5.1. Structure of Easily-Refilled Laser Cartridge.....	4
1.5.2. Steps of Filling the Easily-Refilled Laser Cartridge.....	5
2. Paper and Print Media	7
2.1. Paper Specification	7
2.2. Special Paper.....	8
2.3. Loading Paper.....	9
2.3.1. Loading into the Automatic Feeder Tray.....	9
2.4. Nonprinting Area	11
2.5. Guidelines for Paper Use	11
3. Driver installation and uninstallation	12
3.1. How to install Windows printer driver	12
3.1.1. One-click Installation	12
3.1.2. Manual installation	27
3.1.3. Method of driver unistallation	35
3.2. macOS system driver installation	36
3.3. Add printer to Mac system.....	39
3.3.1. Add up the printer via USB.....	39
3.3.2. Add up the printer via wireline connection	39
3.3.3. Add up the printer via wireless connection	39
4. Wired network setup (applicable to wired network models)	40
4.1. Set IP Address	40
4.1.1. Automatic Setting.....	40
4.1.2. Manual Setting.....	40
5. Wireless network setup (applicable to WiFi models)	41
5.1. Basic structure mode	41
5.1.1. Wireless network setup tools.....	41
5.1.2. How to disable the WiFi network connected.....	44
5.2. WiFi Direct mode	44

5.2.1. Preliminary preparations	44
5.2.2. WiFi Direct connection	44
5.2.3. How to disable the WiFi Direct	45
5.3. Wireless network setup FAQs	45
6. Web server (Applicable to network printers).....	47
6.1. Visit the embedded Web server	47
6.2. Use Web server to manage printer.....	47
6.2.1. Wireless setup	48
6.2.2. Sleep time setup	49
6.2.3. Recover factory settings via Web server	49
7. Print	50
7.1. Print Function.....	50
7.2. Print Settings	51
7.2.1. Print parameter settings	51
7.2.2. Manual duplex print.....	51
7.2.3. Opening Help Document.....	55
7.4. Cancel Print Job.....	55
8. Mobile Print.....	56
8.1. "Pantum" APP.....	56
8.1.1. Operating systems supported	56
8.1.3. How to use this "Pantum" APP.....	56
9. General Settings	58
9.1. Control Panel Overview	58
9.1.1. Functions of Buttons on the Control Panel	59
9.1.2. Function of LED Indicators on the Control Panel.....	59
9.2. System Setting.....	62
9.2.1. Sleep Time Setting.....	62
9.3. Restore Factory Settings.....	63
9.4. Consumable information	63
10. Routine Maintenance	64
10.1. Cleaning the Printer	64
10.2. Maintenance of Laser Toner Cartridge	66
10.2.1. Use and Maintenance of Laser Toner Cartridge.....	66
10.2.2. Service Life of Laser Toner Cartridge.....	66
10.2.3. Replace Laser Toner Cartridge	67
11. Troubleshooting	69
11.1. Clearing Jammed Paper	69

11.1.1. Paper Jam in the Feed Port	70
11.1.2. Paper Jam inside the Printer	70
11.2. Common Troubleshooting	73
11.2.1. Common Trouble	73
11.2.2. Image Defects.....	74
12. Product Specification	77
12.1. Specification Overview.....	77
12.2. Print Specifications.....	77

1. Before Using the Printer

1.1. Product series introduction





Product series parameters	P2210 Series	P2510 Series	P2210W Series	P2510W Series
Interface type	USB	●	●	●
	NET			
	WiFi			●
	GDI	●	●	●
	LED	●	●	●
Print Speed(A4)	20ppm	●	●	
	22ppm			●
Manual duplex print	●	●	●	●

(●: Support; Blank: Unsupport)

 **Note:** • This product series is subject to additions or changes without prior notice.

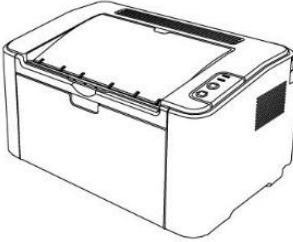
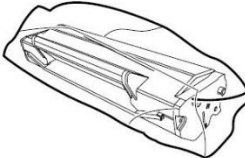
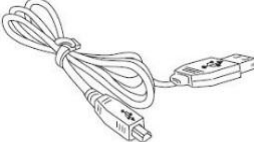
1.2. Supplied Accessories

When you open the package, make sure that the following parts are included in the carton:

Name	Parts
Printer	
Laser Toner Cartridge	
USB Interface Cable	
Power Cord	
CD-ROM	
Installation Manual	
Pantum Warranty	

 **Note:** • The Pantum Warranty may not be attached in some regions.

1.3. Product View

| Front View

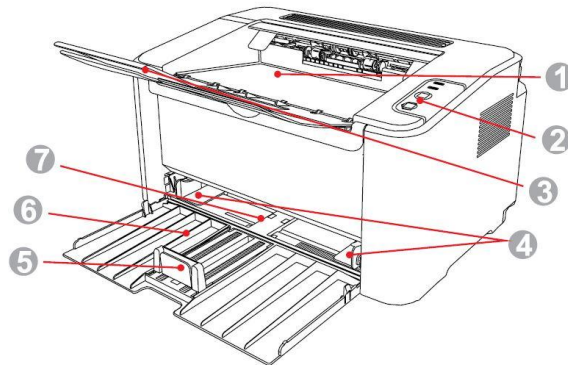

1	Output Bin
2	Control Panel
3	Output Tray
4	Automatic Feed Guide
5	Paper Stop
6	Feeder Tray
7	Automatic Feeder Tray

| Rear View

 **Note:** • The rear view of the printer may vary depending on the models and functions.

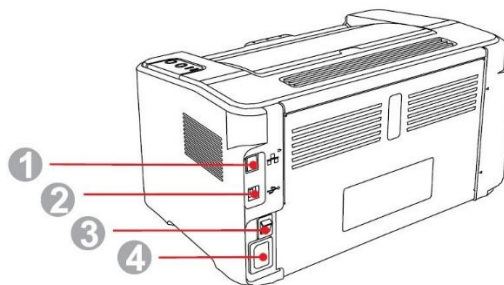

1	Network Interface
2	USB Interface
3	Power Switch
4	Power Interface

1.4. Laser Toner Cartridge

| Service Life of the Laser Toner Cartridge

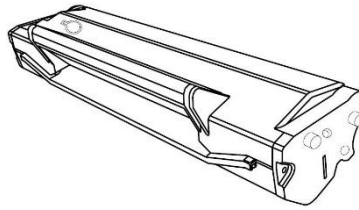

Type	Average Print Volume
Laser Toner Cartridge with Standard Capacity	About 700 Pages (The above data is based on ISO/IEC 19752 standard)
Laser Toner Cartridge with High Capacity	About 1600 Pages (The above data is based on ISO/IEC 19752 standard)



Note: • The model is subject to increase without notice.

- Consumables capacity may vary depending on the types used.
- The Company does not recommend using consumables other than the original consumables provided, as any damages caused by non-original consumables are not covered by the scope of warranty.
- Toner cartridge appearance may differ because of multiple volume and models, so the schematic diagram is only for your reference.

1.5. Easily-Refilled Laser Toner Cartridge

1.5.1. Structure of Easily-Refilled Laser Cartridge

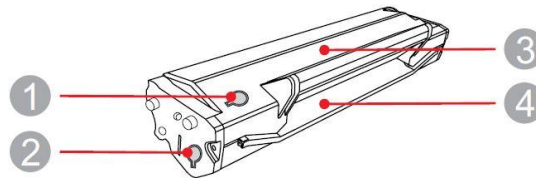

No.	Name
1	Waste Toner Port
2	Toner Refilling Port
3	Waste Toner Box
4	Toner Box

1.5.2. Steps of Filling the Easily-Refilled Laser Cartridge

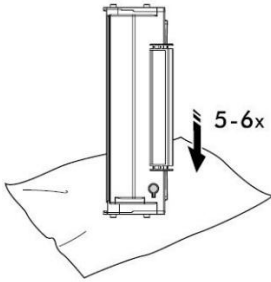
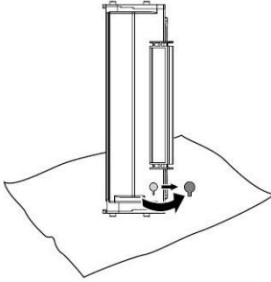
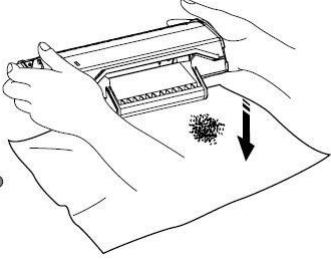
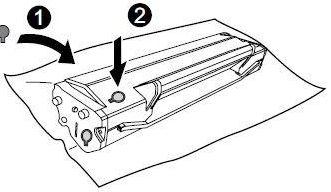
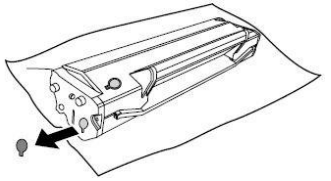
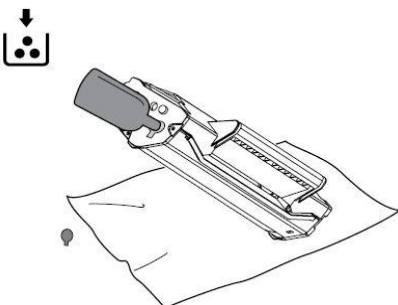
Steps	Diagram	Description
1		Hold the laser toner cartridge with the toner port side down and shake it vertically around 5-6 times.
2		Open the cover of the waste toner port.
3		Pour out the waste toner from the waste toner box.
4		Close the cover of the waste toner port.
5		Open the cover of the toner refilling port.
6		Align the mouth of the toner bottle to the toner refilling port.

7

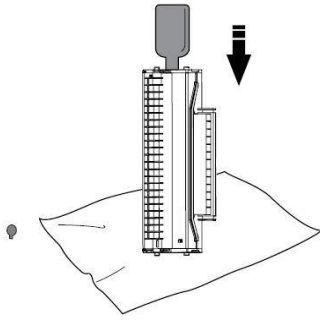

Pour the toner into the toner box.

8

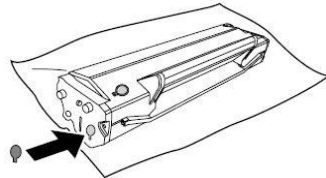

Close the cover of the toner refilling port.

9

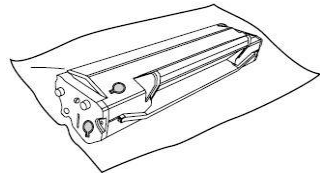

The toner refilling is completed.



- Note:**
- Do NOT incinerate new or waste toner or toner cartridge. Toner will combust when exposed to flame and operator may get burnt.
 - Do NOT use an ordinary vacuum to clean up spilled toner. The toner may be exposed to spark inside the vacuum and thus cause a fire or explosion. You can use an anti-explosion vacuum with a dust fire protection device.
 - If you inhaled toner, please gargle with plenty of water and go to an environment with fresh air. Go to the hospital when necessary.
 - If the clothes are stained with toner, wipe clothes with a dry duster and then clean them with cold water. Hot water will cause toner to penetrate fibers of clothes.
-

2. Paper and Print Media

2.1. Paper Specification

	Media Type	Plain, thin, special paper (transparency, cardstock, label, envelope, thick, etc.).
Automatic Feeder Tray	Media Size	A4, A5, JIS B5, ISO B5, A6, Letter, Legal, Executive, Folio, Oficio, Statement, Japanese Postcard, Monarch Env, DL Env, C5 Env, C6, Env, No.10 Env, ZL, Big 16K, Big 32K, 16K, 32K, B6, Yougata4, Postcard, Younaga3, Nagagata3, Yougata2, custom, etc.
	Media Weight	60~163g/m ²
	Maximum Capacity of the Tray	150 pages (80g/m ²)



Note: • It is recommended to use the standard paper for the printer.

- Extensive use of special paper may affect the service life of the printer.
 - The print media that does not meet the guidelines set out in this User Guide may result in poor print quality, increased paper jam and excessive wear of the printer.
 - Properties such as weight, composition, texture and humidity are important factors affecting the printer performance and output quality.
 - Please note the following matters when selecting the print media:
 1. Desired print effect: The print media selected should meet the requirement of the print tasks.
 2. Surface smoothness: The smoothness of the print media may affect the sharpness of the print outcome.
 3. Some print media may meet all the use guidelines contained herein, but they still can not bring satisfactory effect. This may be due to incorrect operation, inappropriate temperature and humidity, or other factors beyond the control of Pantum. Before purchasing large quantities of print media, make sure that the print media meets the specifications specified in this User Guide.
 4. Using print media that does not meet these specifications may cause damage to the printer.
-

2.2. Special Paper

This printer supports using the special paper for printing. Special paper includes: label, envelope, transparency, thick, cardstock, etc.



- Note:** • When using special paper or print media, be sure to select matched print type and size in the print settings so as to get the best print effect.
- When using special media to print, it is recommended to load one piece of paper at one time.

| Please observe the following standards:

Types of Print Media	Correct Practices	Incorrect Practices
Label	Use labels with no exposed lining paper only. Labels shall be put flat when using. Use labels of full sheet only. There is no guarantee that all the labels in the market can meet corresponding requirements.	Use wrinkled, blistering or damaged labels.
Envelope	Envelopes should be loaded evenly.	Use wrinkled, nicked, stuck or damaged envelopes. Use envelopes with clips, snaps, Windows, or coated linings. Use envelopes with self-adhesive stickers or other synthetic materials.
Transparency	Use only transparencies approved for use in laser printers.	Use transparent print media that is not suitable for laser printers.
Thick, Cardstock	Use only heavy paper that is approved for use in laser printers and meets the weight specifications of this printer.	Use paper whose weight exceeds the recommended media specifications of this printer.

2.3. Loading Paper

2.3.1. Loading into the Automatic Feeder Tray

1. Open the feeder tray.

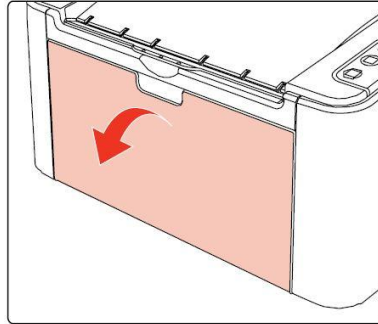

2. Slide the automatic feed guides to match both sides of the paper.

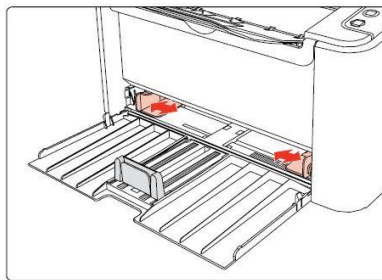

3. Raise the output tray to avoid the paper from slipping and falling.

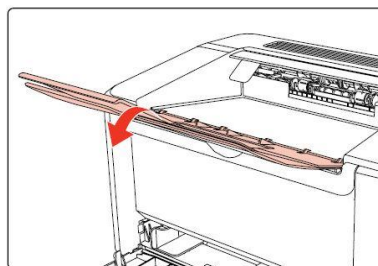

4. Load the paper into the automatic tray with the print-side up.

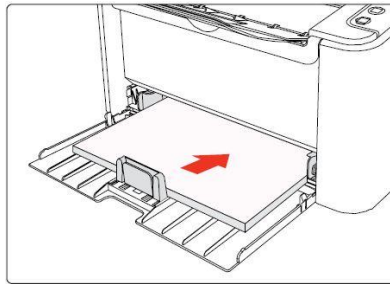

 **Note:** • Before loading paper, please unfold the stacked paper to avoid a paper jam or feed error, and then load the paper into the tray print-side up.

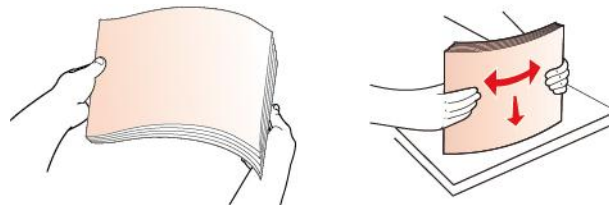

5. Adjust the paper stop to keep the paper in position. To ensure normal paper feeding, adjust the bottom paper stop ① into the slot to keep it from slipping out, and then adjust the blue stop ② to match the paper size.

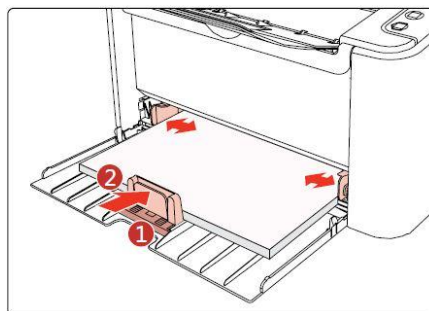

 **Note:** • Paper may get jammed or cannot be fed in when the automatic tray is loaded with more than 150 sheets.

- When using the printed paper, please make the side to be printed (the blank side) up.
- When printing on A5 paper, it is recommended that the paper is fed in landscape orientation, which can extend the service life of the laser toner cartridge.

2.4. Nonprinting Area

The shaded section indicates the nonprinting area.

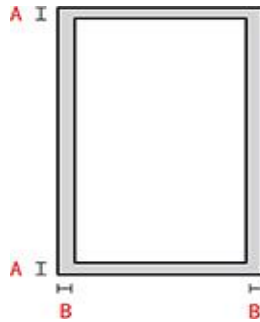

Usage	Paper Size	Top and Bottom Margins (A)	Left and Right Margins (B)
Printing	A4	5 mm (0.197 inch)	5 mm (0.197 inch)
	Letter	5 mm (0.197 inch)	5 mm (0.197 inch)

2.5. Guidelines for Paper Use

- Paper or manuscript with rough texture, concave and convex, oil stain and good smoothness has poor printing performance.
- Please make sure that there is no dust, fluff, etc. on the paper.
- Paper shall be put on a flat surface and stored under a cool and dry environment.

3. Driver installation and uninstallation

3.1. How to install Windows printer driver

Windows driver installation software provides two installing methods: one-click installation and manual installation. We recommend one-click installation, which can help to install driver automatically in a faster and more convenient way. If you have any difficulty in using one-click installation, please try manual installation.



Note: • Driver installation interface may differ because of different models and functions, so the schematic diagram is only for your reference.

3.1.1. One-click Installation

One-click installation provides three methods of installation: connect the printer via USB cable, connect the printer via wired network, and connect the printer via wireless network. You can choose one of them according to your habit.

3.1.1.1. Method I: Connect the printer via USB cable

1. Connect the printer to computer via USB cable, power the printer and computer on.
2. Place the attached installation CD in the computer CD-ROM:
 - Windows XP system: automatically run the installation procedure.
 - Windows 7/Vista/Server 2008 system: Pop up "Autoplay" interface, click "Autorun.exe" to run the installation procedure.
 - Windows 8 system: When the "DVD RW driver" window pops up from the right top corner of computer desktop, click anywhere in the pop-up window, then click "Autorun.exe" to run the installation procedure.
 - Windows 10 system: When the "DVD RW driver" window pops up from the right top corner of computer desktop, click anywhere in the window, then click "Autorun.exe" to run the installation procedure.



Note: • Some computers may be unable to auto play the CD because of system configuration. Please double click "Computer" icon, find "DVD RW driver", then double click "DVD RW driver" to run the installation procedure.

3. Read and agree to the terms contained in the End User License Agreement and the Privacy Policy, click the "Next" button in the lower right corner of the interface to enter the driver installation interface.

4. Click on the "One-click installation" button in Method I and enter into the installation process. The process may need some time, and the duration is related to your computer configuration, please wait patiently.

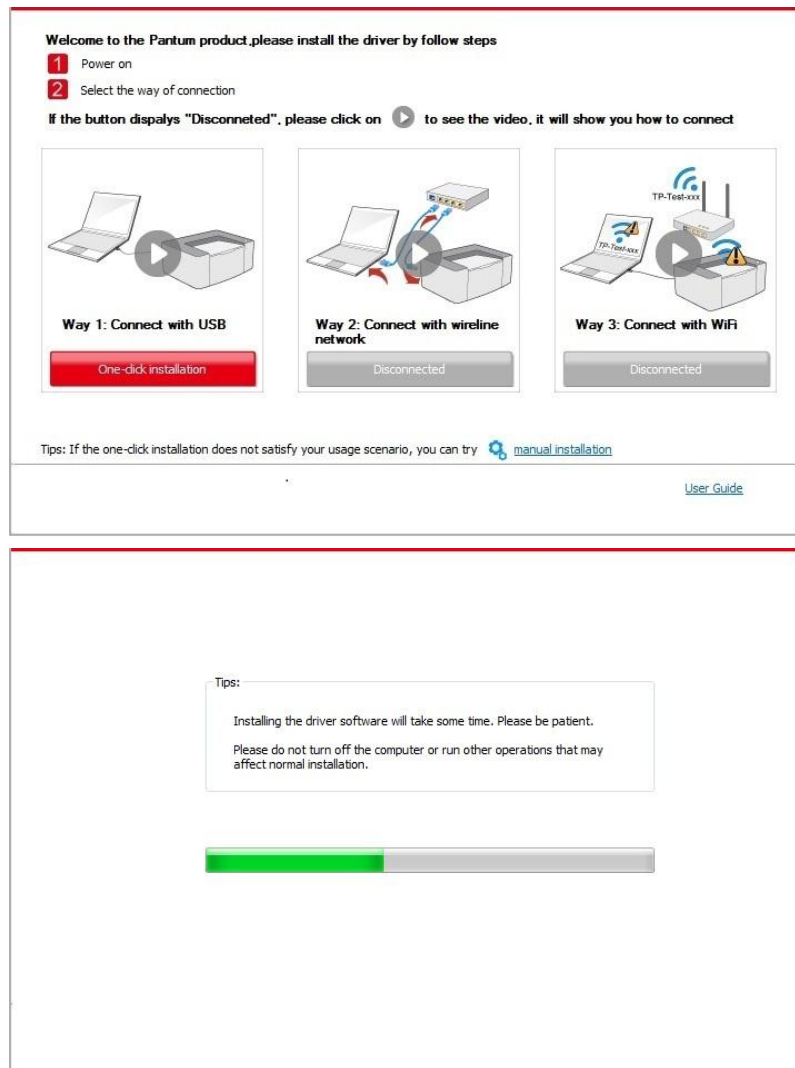

5. After the installation, click "Print & Test Page" button. If your printer prints the test page successfully, it means that you have installed the driver correctly.

3.1.1.2. Method II: Connect the printer via wired network (applicable to wired network models)

1. Turn the power of printer and computer on.
2. Connect the computer to wired network.
3. Connect network cable to the network interface of printer, to make sure the printer is connected to computer network (please refer to [Chapter 4](#) for network setup).
4. Place the attached installation CD in the computer CD-ROM:
 - Windows XP system: automatically run the installation procedure.

- Windows 7/Vista/Server 2008 system: Pop up "Autoplay" interface, click "Autorun.exe" to run the installation procedure.
- Windows 8 system: When the "DVD RW driver" window pops up from the right top corner of computer desktop, click anywhere in the pop-up window, then click "Autorun.exe" to run the installation procedure.
- Windows 10 system: When the "DVD RW driver" window pops up from the right top corner of computer desktop, click anywhere in the window, then click "Autorun.exe" to run the installation procedure.



Note: • Some computers may be unable to auto play the CD because of system configuration. Please double click "Computer" icon, find "DVD RW driver", then double click "DVD RW driver" to run the installation procedure.

5. Read and agree to the terms contained in the End User License Agreement and the Privacy Policy, click the "Next" button in the lower right corner of the interface to enter the driver installation interface.
6. Please click on the "One-click installation" button in Method II and install driver software.



Note: • You can put your mouse cursor in the "One-click installation" button to check the popup information in order to confirm if the current printer is the one you need to install through IP address before you click the button.



- You can check the printer IP address through "Network configuration page" (Please see [Chapter 9.1.1.3](#) for how to print)
-

- Click on the "One-click installation" button to enter installation process if your software has searched only one printer. The process may need some time, and the duration is related to your computer configuration. Please wait patiently.

Welcome to the Pantum product, please install the driver by follow steps

- 1 Power on
- 2 Select the way of connection

If the button displays "Disconnected", please click on  to see the video, it will show you how to connect

 Way 1: Connect with USB Disconnected	 Way 2: Connect with wireline network One-click installation	 Way 3: Connect with WiFi Disconnected
---	--	---

Tips: If the one-click installation does not satisfy your usage scenario, you can try [manual installation](#)

[User Guide](#)

Tips:

Installing the driver software will take some time. Please be patient.

Please do not turn off the computer or run other operations that may affect normal installation.

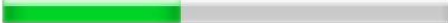

- If your software has searched several printers, click on the "One-click installation" button, and the printer list interface will pop up. Please select the printer that you need according to your printer wired network IP address or host ID.

Welcome to the Pantum product, please install the driver by follow steps

- 1 Power on
- 2 Select the way of connection

If the button displays "Disconnected", please click on  to see the video, it will show you how to connect



Way 1: Connect with USB

Disconnected



Way 2: Connect with wireline network

One-click installation



Way 3: Connect with WiFi

Disconnected

Tips: If the one-click installation does not satisfy your usage scenario, you can try [manual installation](#)

[User Guide](#)

Please select the printer you would like to install

Configure and install WiFi via USB

Printer Name	Port

Wireline network printer

Printer Name	IP Address	Host name
<input checked="" type="checkbox"/> X X X Series PCL6 0001	10.10.148.119	X X X -0482E7
<input type="checkbox"/> X X X Series PCL6 0002	10.10.148.155	X X X -048304

Install the printer from the list with a hostname [?](#)

Tips: If your printer is not in the list, please check the printer network status and see if it is in the same network as the current PC

Tips:

Installing the driver software will take some time. Please be patient.

Please do not turn off the computer or run other operations that may affect normal installation.





Note: • If the printer you need is not shown in the list, please click "Refresh" button to search again. If it is not found, please check if the printer and computer are in the same network.

- When the printer IP address changes under printer driver installed with host ID , you can also directly print without re-installing the driver. If you need to install the printer driver with the host ID, please check the option "Install the printer in the list with host ID".

7. After the installation, click "Print & Test Page" button. If your printer prints the test page successfully, it means that you have installed the driver correctly.

3.1.1.3. Method III: Connect the printer via wireless network(Applicable to wireless model)

Please check if the printer is connected with wireless network when installing the printer driver software. If disconnected, please install it with reference to [Chapter 3.1.1.3.1](#). If connected, please install it with reference to [Chapter 3.1.1.3.2](#).



Note: • You can print "Network configuration page" to confirm printer network connection status to see if printer is connected with network (Please see [Chapter 9.1.1.3](#) for how to print).

3.1.1.3.1. The printer is not connected with wireless network

3.1.1.3.1.1. Configure wireless network via USB cable and install driver

Since some computers are not provided with wireless network function, this section is divided into "Connect computer to router via WiFi " and "Connect computer to router via wired connection" to introduce installation process.

I. Connect computer to router via WiFi

1. Computer is already connected to router via WiFi .
2. Connect the printer to computer via USB cable, then power the printer on.
3. Place the attached installation CD in the computer CD-ROM:
 - Windows XP system: automatically run the installation procedure.
 - Windows 7/Vista/Server 2008 system: Pop up "Autoplay" interface, click "Autorun.exe" to run the installation procedure.
 - Windows 8 system: When the " DVD RW driver" window pops up from the right top corner of computer desktop, click anywhere in the pop-up window, then click "Autorun.exe" to run the installation procedure.
 - Windows 10 system: When the "DVD RW driver" window pops up from the right top corner of computer desktop, click anywhere in the window, then click "Autorun.exe" to run the installation procedure.

 **Note:**• Some computers may be unable to auto play the CD because of system configuration. Please double click "Computer" icon, find "DVD RW driver", then double click "DVD RW driver" to run the installation procedure.

4. Read and agree to the terms contained in the End User License Agreement and the Privacy Policy, click the "Next" button in the lower right corner of the interface to enter the driver installation interface.
5. Click the "One-click installation" button in Method III to install driver software.

 **Note:**• You can put your mouse cursor in the "One-click installation" button to check the popup information in order to confirm if the current printer is the one you need to install through IP address before you click the button.

- You can check the printer IP address through "Network configuration page" (Please see [Chapter 9.1.1.3](#) for how to print)

- Click "One-click installation" button if your software has searched only one printer, and enter into installation process to complete automatic network configuration and driver installation.

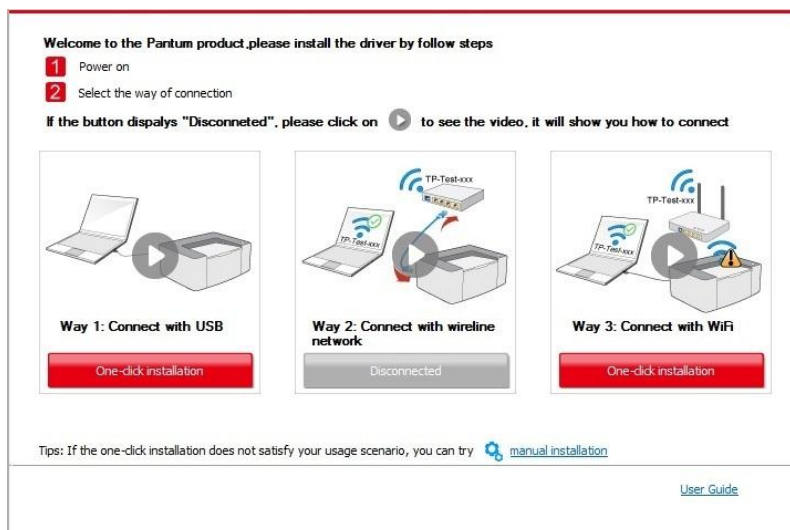

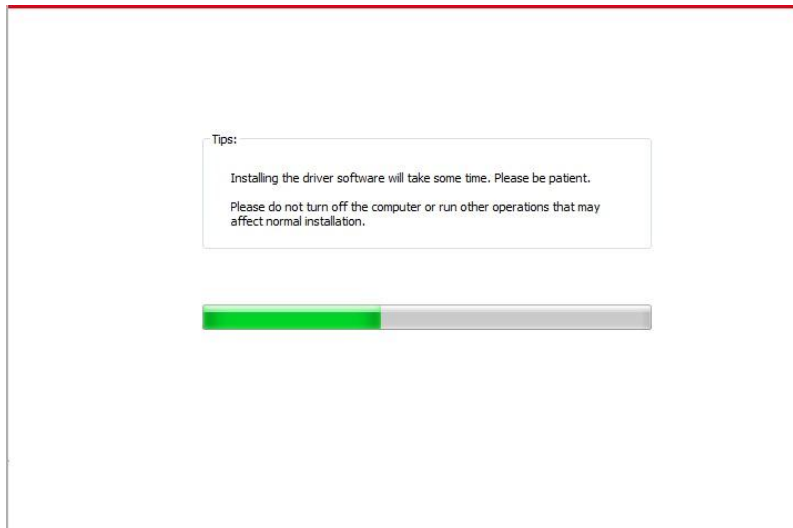

- If your software has searched several printers, click "One-click intallation" button, and the printer list interface will pop up. Please select "Configure printer with WiFi via USB and install" and select USB printer, click "Confirm" button and enter into installation process to complete automatic network configuration and driver installation.

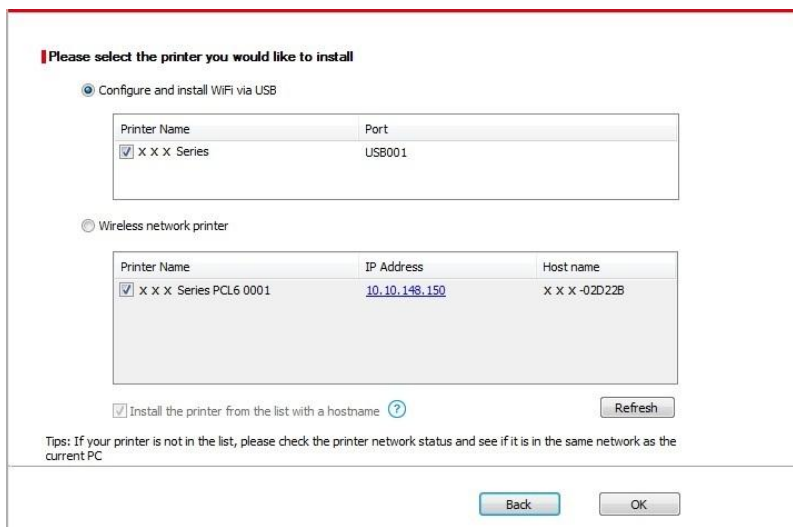
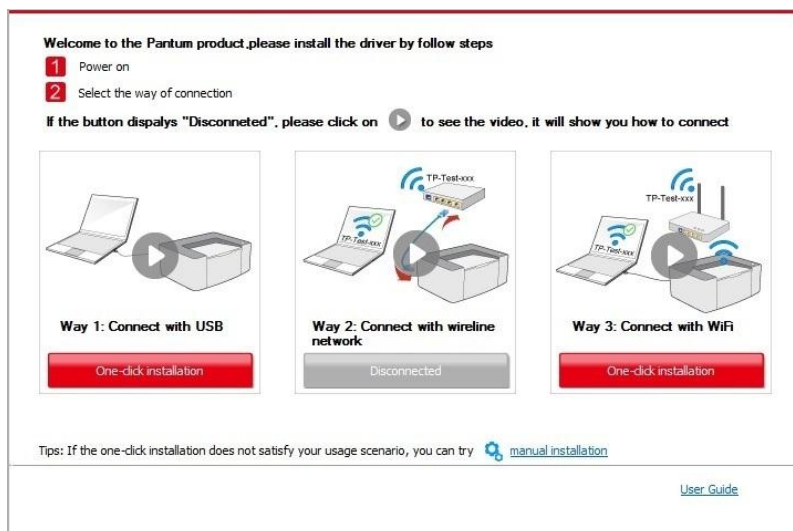

 **Note:**• When the printer IP address changes under printer driver installed with host ID , you can also directly print without re-installing the driver. If you need to install the printer driver with the host ID, please check the option "Install the printer in the list with host ID".

6. After the installation, click "Print &Test Page" button. If your printer prints the test page successfully, it means that you have installed the driver correctly.

II. Connect computer to router via network cable

1. Connect computer to router via network cable.
2. Connect the printer to computer via USB cable, then power the printer on.
3. Place the attached installation CD in the computer CD-ROM:
 - Windows XP system: automatically run the installation procedure.
 - Windows 7/Vista/Server 2008 system: Pop up "Autoplay" interface, click "Autorun.exe" to run the installation procedure.
 - Windows 8 system: When the " DVD RW driver" window pops up from the right top corner of computer desktop, click anywhere in the pop-up window, then click "Autorun.exe" to run the installation procedure.
 - Windows 10 system: When the "DVD RW driver" window pops up from the right top corner of computer desktop, click anywhere in the window, then click "Autorun.exe" to run the installation procedure.

 **Note:**• Some computers may be unable to auto play the CD because of system configuration. Please double click "Computer" icon, find "DVD RW driver", then double click "DVD RW driver" to run the installation procedure.

4. Read and agree to the terms contained in the End User License Agreement and the Privacy Policy, click the "Next" button in the lower right corner of the interface to enter the driver installation interface.
5. Please click on the "One-click installation" button in Method III and install driver software.

 **Note:**• You can put your mouse cursor in the "One-click installation" button to check the popup information in order to confirm if the current printer is the one you need to install through IP address before you click the button.



- You can check the printer IP address through "Network configuration page" (Please see [Chapter 9.1.1.3](#) for how to print).

- Click on the "One-click installation" button if your software has only searched only one printer, and the wireless network configuration interface will pop up, input the SSID and password that you need, then click "Confirm" button, and enter into installation process. The process may need some time, and the duration is related to your computer configuration, please wait patiently.

Welcome to the Pantum product, please install the driver by follow steps

- 1 Power on
- 2 Select the way of connection

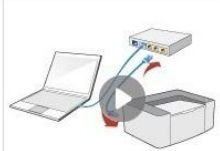
If the button displays "Disconnected", please click on  to see the video, it will show you how to connect

 Way 1: Connect with USB <input type="button" value="One-click installation"/>	 Way 2: Connect with wireline network <input type="button" value="Disconnected"/>	 Way 3: Connect with WiFi <input type="button" value="One-click installation"/>
--	---	--

Tips: If the one-click installation does not satisfy your usage scenario, you can try [manual installation](#)

[User Guide](#)

1. Please click on "Printing wireless network information page" to get the network name and encryption method. Please skip this step if you already know the network name and encryption method.

2. Please enter wireless network user name and password.

Network Name(SSID):

Encryption method:

Password:

Show password:

- If your software has searched more than one printers, the printer list interface will pop up. You need to configure the current printer which is connected via USB cable to wireless network and install driver. Please select "Configure the print via USB and install" on the printer list interface and check the USB printer option. Click the "Confirm" button, and the wireless network configuration interface will pop up. Input the wireless SSID and password that you need, then click "Confirm" button, and enter into installation process. The process may need some time, and the duration is related to your computer configuration, please wait patiently.

Welcome to the Pantum product, please install the driver by follow steps

- 1 Power on
- 2 Select the way of connection

If the button displays "Disconnected", please click on  to see the video, it will show you how to connect



Way 1: Connect with USB

One-click installation



Way 2: Connect with wireline network

Disconnected



Way 3: Connect with WiFi

One-click installation

Tips: If the one-click installation does not satisfy your usage scenario, you can try [manual installation](#)

[User Guide](#)

Please select the printer you would like to install

Configure and install WiFi via USB

Printer Name	Port
<input checked="" type="checkbox"/> X X X Series	USB001

Wireless network printer

Printer Name	IP Address	Host name
<input checked="" type="checkbox"/> X X X Series PCL6 0001	10.10.148.150	X X X -02D22B

Install the printer from the list with a hostname [?](#) Refresh

Tips: If your printer is not in the list, please check the printer network status and see if it is in the same network as the current PC

Back
OK

1. Please click on "Printing wireless network information page" to get the network name and encryption method. Please skip this step if you already know the network name and encryption method.

2. Please enter wireless network user name and password.

Network Name(SSID):

Encryption method:

Password:

Show password:

 **Note:** • When the printer IP address changes under printer driver installed with host ID , you can also directly print without re-installing the driver. If you need to install the printer driver with the host ID, please check the option "Install the printer in the list with host ID".

6. After the installation, click "Print &Test Page" button. If your printer prints the test page successfully, it means that you have installed the driver correctly.

3.1.1.3.1.2. Connect computer to printer via WiFi direct and install the driver

Connect the computer to printer via a direct WiFi connection. It is applicable to wireless network without infrastructure mode, but it still needs scenario of temporary use of printer via wireless network. You can directly connect the computer that has wireless function to the printer to realize printing function.

1. Turn the power of printer and computer on.
2. Connect computer to the WiFi Direct network of the printer (please refer to [Chapter 5.2.2](#) for setup method).
3. Place the attached installation CD in the computer CD-ROM:
 - Windows XP system: automatically run the installation procedure.
 - Windows 7/Vista/Server 2008 system: Pop up "Autoplay" interface, click "Autorun.exe" to run the installation procedure.
 - Windows 8 system: When the "DVD RW driver" window pops up from the right top corner of computer desktop, click anywhere in the pop-up window, then click "Autorun.exe" to run the installation procedure.
 - Windows 10 system: When the "DVD RW driver" window pops up from the right top corner of computer desktop, click anywhere in the window, then click "Autorun.exe" to run the installation procedure.

 **Note:**• Some computers may be unable to auto play the CD because of system configuration. Please double click "Computer" icon, find "DVD RW driver", then double click "DVD RW driver" to run the installation procedure.

4. Read and agree to the terms contained in the End User License Agreement and the Privacy Policy, click the "Next" button in the lower right corner of the interface to enter the driver installation interface.

5. Click on the "One-click installation" button in Method III, and enter into installation process. The process may need some time, and the duration is related to your computer configuration, please wait patiently.

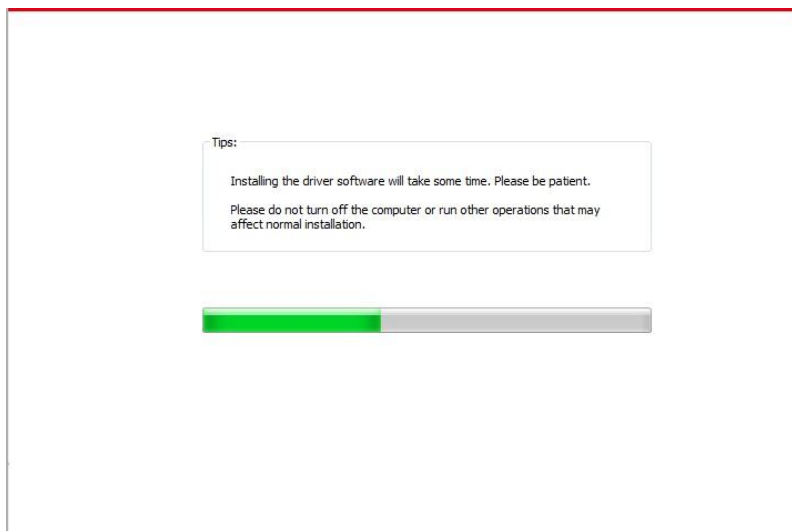
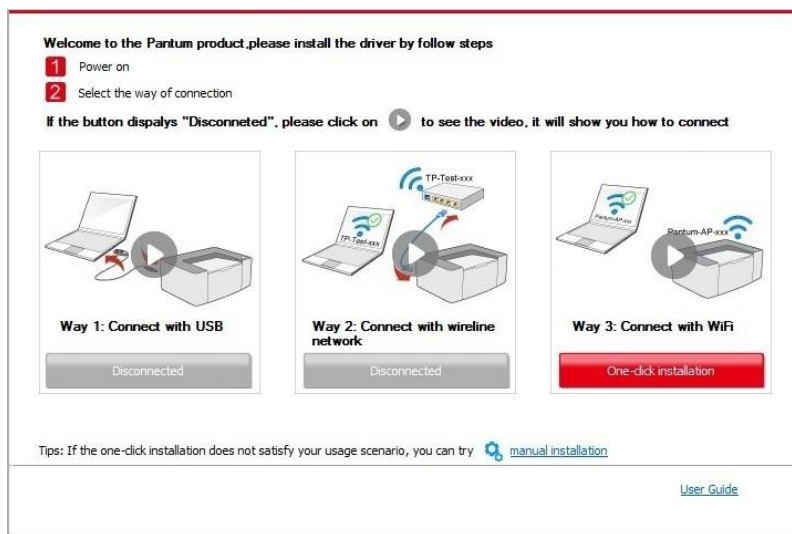

6. After the installation, click "Print & Test Page" button. If your printer prints the test page successfully, it means that you have installed the driver correctly.

3.1.1.3.2. The printer is already connected to wireless network

1. The printer is already connected to wireless network, you can print the "Network configuration page" to check.(See [Chapter 9.1.1.3](#) to for how to print).
2. Connect the computer to printer network.
3. Place the attached installation CD in the computer CD-ROM:
 - Windows XP system: automatically run the installation procedure.
 - Windows 7/Vista/Server 2008 system: Pop up "Autoplay" interface, click "Autorun.exe" to run the installation procedure.
 - Windows 8 system: When the "DVD RW driver" window pops up from the right top corner of computer desktop, click anywhere in the pop-up window, then click "Autorun.exe" to run the installation procedure.
 - Windows 10 system: When the "DVD RW driver" window pops up from the right top corner of computer desktop, click anywhere in the window, then click "Autorun.exe" to run the installation procedure.



Note:• Some computers may be unable to auto play the CD because of system configuration.

Please double click "Computer" icon, find "DVD RW driver", then double click "DVD RW driver" to run the installation procedure.

4. Read and agree to the terms contained in the End User License Agreement and the Privacy Policy, click the "Next" button in the lower right corner of the interface to enter the driver installation interface.
5. Click the "One-click installation" button in Method III to install driver software.



Note:• You can put your mouse cursor in the "One-click installation" button to check the popup information in order to confirm if the current printer is the one you need to install through IP address before you click the button.

- You can check the printer IP address through "Network configuration page" (Please see [Chapter 9.1.1.3](#) for how to print)
-

- Click on the "One-click installation" button to enter installation process if your software has searched only one printer. The process may need some time, and the duration is related to your computer configuration. Please wait patiently.

Welcome to the Pantum product, please install the driver by follow steps

- 1 Power on
- 2 Select the way of connection

If the button displays "Disconnected", please click on  to see the video, it will show you how to connect



Way 1: Connect with USB

Disconnected



Way 2: Connect with wireline network

Disconnected



Way 3: Connect with WiFi

One-click installation

Tips: If the one-click installation does not satisfy your usage scenario, you can try [manual installation](#)

[User Guide](#)

Tips:

Installing the driver software will take some time. Please be patient.

Please do not turn off the computer or run other operations that may affect normal installation.



- If the software has searched several printers, the printer list interface will pop up. Please select the printer you need according to your printer wired network IP address or host ID .

Welcome to the Pantum product, please install the driver by follow steps

- 1 Power on
- 2 Select the way of connection

If the button displays "Disconnected", please click on  to see the video, it will show you how to connect



Way 1: Connect with USB

Disconnected



Way 2: Connect with wireline network

Disconnected



Way 3: Connect with WiFi

One-click installation

Tips: If the one-click installation does not satisfy your usage scenario, you can try [manual installation](#)

[User Guide](#)

Please select the printer you would like to install

Configure and install WiFi via USB

Printer Name	Port

Wireless network printer

Printer Name	IP Address	Host name
<input checked="" type="checkbox"/> X X X Series PCL6 0001	10.10.148.150	X X X -02D22B
<input type="checkbox"/> X X X Series PCL6 0002	10.10.148.152	X X X -02D84A

Install the printer from the list with a hostname [?](#)

Tips: If your printer is not in the list, please check the printer network status and see if it is in the same network as the current PC



Note: If the printer you need is not shown in the list, please click "Refresh" button to search again. If it is not found, please check if the printer and computer are in the same network. (Please see [Chapter 5.3](#) for how to check).

- When the printer IP address changes under printer installed with host ID , you can also directly print without re-installing the driver. If you need to install the printer driver with the host ID, please check the option "Install the printer in the list with host ID".

6. After the installation, click "Print & Test Page" button. If your printer prints the test page successfully, it means that you have installed the driver correctly.

3.1.2. Manual installation

- Before installing the drive, you need to learn about printer model by printing printer information page out and check the product name (please refer to [Chapter 9.1.1.3](#) for printing methods).

3.1.2.1. Installation via USB connection

1. Connect the printer to computer via USB cable, power the printer and computer on.
2. Place the attached installation CD in the computer CD-ROM:
 - Windows XP system: automatically run the installation procedure.
 - Windows 7/Vista/Server 2008 system: Pop up "Autoplay" interface, click "Autorun.exe" to run the installation procedure.
 - Windows 8 system: When the "DVD RW driver" window pops up from the right top corner of computer desktop, click anywhere in the pop-up window, then click "Autorun.exe" to run the installation procedure.
 - Windows 10 system: When the "DVD RW driver" window pops up from the right top corner of computer desktop, click anywhere in the window, then click "Autorun.exe" to run the installation procedure.



Note:• Some computers may be unable to auto play the CD because of system configuration. Please double click "Computer" icon, find "DVD RW driver", then double click "DVD RW driver" to run the installation procedure.

3. Read and agree to the terms contained in the End User License Agreement and the Privacy Policy, click the "Next" button in the lower right corner of the interface to enter the driver installation interface.
4. Click on the "Manual installation" at the bottom of driver installation interface, and enter into manual installation interface.
5. Please select installation language and printer model.
6. Select "Connect via USB" and click on "Install".

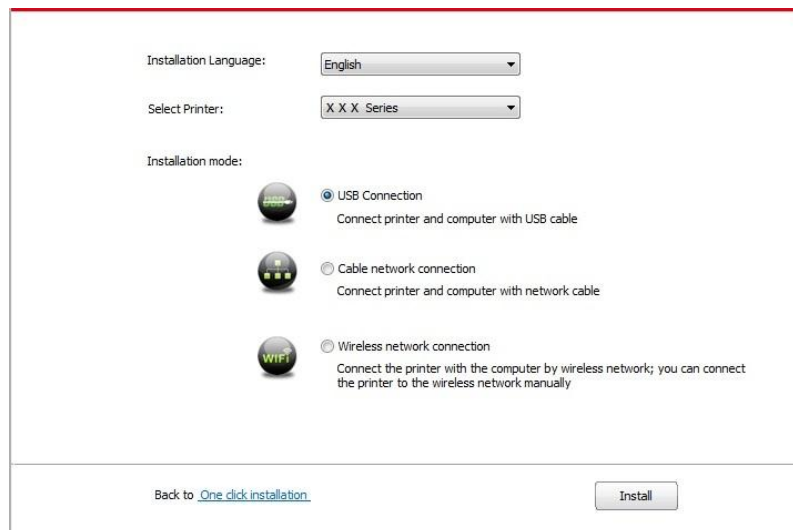

7. The software installs the driver automatically and the installation process may need some time. The duration is related to your computer configuration, please wait patiently.
8. After the installation, click "Print & Test Page" button. If your printer prints the test page successfully, it means that you have installed the driver correctly.

3.1.2.2. Installation via wired network connection (applicable to wired network models)

1. Turn the power of printer and computer on.
2. Connect the computer to wired network.
3. Connect network cable to the network interface of printer, to make sure the printer is connected to computer network (please refer to [Chapter 4](#) for network setup).
4. Place the attached installation CD in the computer CD-ROM:
 - Windows XP system: automatically run the installation procedure.

- Windows 7/Vista/Server 2008 system: Pop up "Autoplay" interface, click "Autorun.exe" to run the installation procedure.
- Windows 8 system: When the "DVD RW driver" window pops up from the right top corner of computer desktop, click anywhere in the pop-up window, then click "Autorun.exe" to run the installation procedure.
- Windows 10 system: When the "DVD RW driver" window pops up from the right top corner of computer desktop, click anywhere in the window, then click "Autorun.exe" to run the installation procedure.



Note: • Some computers may be unable to auto play the CD because of system configuration. Please double click "Computer" icon, find "DVD RW driver", then double click "DVD RW driver" to run the installation procedure.

5. Read and agree to the terms contained in the End User License Agreement and the Privacy Policy, click the "Next" button in the lower right corner of the interface to enter the driver installation interface.
6. Click on the "Manual installation" at the bottom of driver installation interface, and enter into manual installation interface.
7. Please select installation language and printer model.
8. Select "Wireline network connection" and click on "Install".

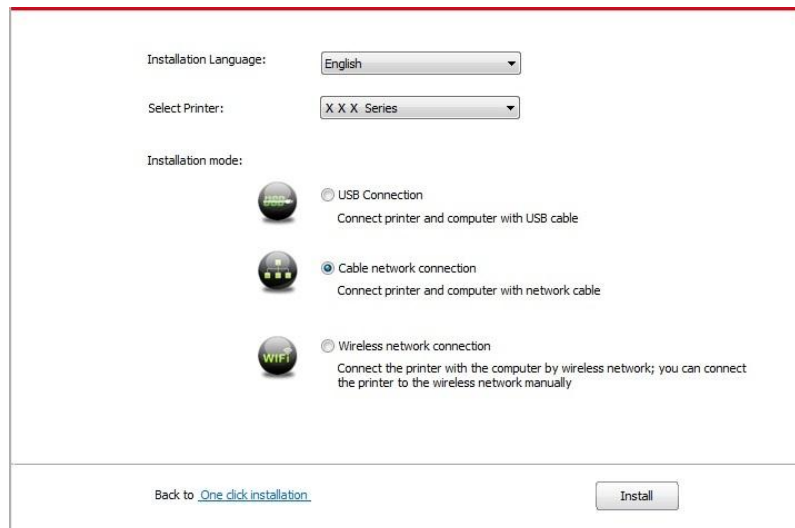

9. The installation software will search the printer automatically and the searching process may need some time.

10. After finishing searching, select the printer that needs to be connected and click “Next”.

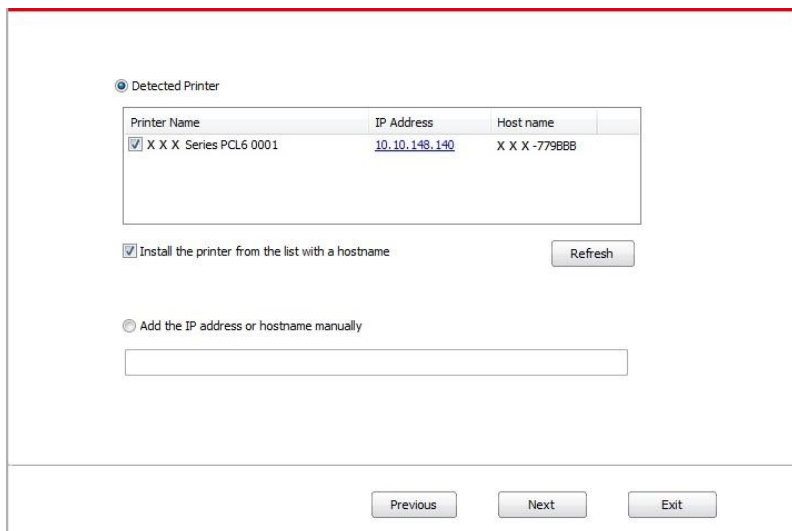

 **Note:**• If the printer you need to connect is not in the list of printers searched, please click “Refresh” to search again.

- When the printer IP address changes under printer driver installed with host ID , you can also directly print without re-installing the driver. If you need to install the printer driver with the host ID, please check the option "Install the printer in the list with host ID".
- If IP address or host name is added manually, you need to know the IP address of the printer connected or host name. If they are not made clear, please print the “NetConf Pg” and view “IP Address” and “Host name” (Please refer to [Chapter 9.1.1.3](#)).

11. The software installs the driver automatically and the installation process may need some time. The duration is related to your computer configuration, please wait patiently.

12. After the installation, click "Print & Test Page" button. If your printer prints the test page successfully, it means that you have installed the driver correctly.

3.1.2.3. Installation by wireless network connection mode (Applicable to wireless model)

Wireless network connection type is divided into basic structure mode and WiFi Direct mode (please refer to [Chapter 5](#) for details).

3.1.2.3.1. Installation in basic structure mode

1. Connect computer to access point (wireless router).
2. Connect the printer to computer via USB cable, then power the printer on.
3. Place the attached installation CD in the computer CD-ROM:
 - Windows XP system: automatically run the installation procedure.

- Windows 7/Vista/Server 2008 system: Pop up "Autoplay" interface, click "Autorun.exe" to run the installation procedure.
- Windows 8 system: When the "DVD RW driver" window pops up from the right top corner of computer desktop, click anywhere in the pop-up window, then click "Autorun.exe" to run the installation procedure.
- Windows 10 system: When the "DVD RW driver" window pops up from the right top corner of computer desktop, click anywhere in the window, then click "Autorun.exe" to run the installation procedure.



Note: • Some computers may be unable to auto play the CD because of system configuration. Please double click "Computer" icon, find "DVD RW driver", then double click "DVD RW driver" to run the installation procedure.

4. Read and agree to the terms contained in the End User License Agreement and the Privacy Policy, click the "Next" button in the lower right corner of the interface to enter the driver installation interface.
5. Click on the "Manual installation" at the bottom of driver installation interface, and enter into manual installation interface.
6. Please select installation language and printer model.
7. Select "Wireless network connection" and click on "Install".

The screenshot shows a driver installation window with the following elements:

- Installation Language:** A dropdown menu set to "English".
- Select Printer:** A dropdown menu set to "X X X Series".
- Installation mode:** Three radio button options:
 - USB Connection**: Connect printer and computer with USB cable.
 - Cable network connection**: Connect printer and computer with network cable.
 - Wireless network connection**: Connect the printer with the computer by wireless network; you can connect the printer to the wireless network manually.
- Navigation:** A link "Back to [One click installation](#)" and an "Install" button.

8. Select “Yes, I want to configure the printer's wireless network” on the wireless setup window popped out, and operate according to the prompts to set up the printer to wireless network (please refer to [Chapter 5.1.1](#) for setup method).

The installation program will determine whether wireless network of the printer is to be configured based on your choice in this step;

- if you need to configure or change wireless network of the printer, please select “yes” after the printer connects USB;
- if not, please select “no”.

Yes, I want to configure the printer's wireless network.

No, the printer has been connected to wireless network.

Previous Next Exit

9. The installation software will search the printer automatically after wireless network is configured successfully. The search process may need some time.

10. Select the printer needs to be connected and click “Next”.

Detected Printer

Printer Name	IP Address	Host name
<input checked="" type="checkbox"/> X X X Series PCL6 0001	10.10.148.140	X X X -77966B

Install the printer from the list with a hostname

Add the IP address or hostname manually

Previous Next Exit

 **Note:** If the printer you need to connect is not in the list of printers searched, please click “Refresh” to search again.

- When the printer IP address changes under printer driver installed with host ID , you can also directly print without re-installing the driver. If you need to install the printer driver with the host ID, please check the option "Install the printer in the list with host ID".
- If IP address or host name is added manually, you need to know the IP address of the printer connected or host name. If they are not made clear, please print the “NetConf Pg” and view “IP Address” and “Host name” (Please refer to [Chapter 9.1.1.3](#)).

11. The software installs the driver automatically and the installation process may need some time. The duration is related to your computer configuration, please wait patiently.
12. After the installation, click "Print & Test Page" button. If your printer prints the test page successfully, it means that you have installed the driver correctly.

3.1.2.3.2. Installation in WiFi Direct mode

1. Turn the power of printer and computer on.
2. Connect computer to the WiFi Direct network of the printer (please refer to [Chapter 5.2.2](#) for setup method).
3. Place the attached installation CD in the computer CD-ROM:
 - Windows XP system: automatically run the installation procedure.
 - Windows 7/Vista/Server 2008 system: Pop up "Autoplay" interface, click "Autorun.exe" to run the installation procedure.
 - Windows 8 system: When the "DVD RW driver" window pops up from the right top corner of computer desktop, click anywhere in the pop-up window, then click "Autorun.exe" to run the installation procedure.
 - Windows 10 system: When the "DVD RW driver" window pops up from the right top corner of computer desktop, click anywhere in the window, then click "Autorun.exe" to run the installation procedure.

 **Note:** • Some computers may be unable to auto play the CD because of system configuration. Please double click "Computer" icon, find "DVD RW driver", then double click "DVD RW driver" to run the installation procedure.

4. Read and agree to the terms contained in the End User License Agreement and the Privacy Policy, click the "Next" button in the lower right corner of the interface to enter the driver installation interface.
5. Click on the "Manual installation" at the bottom of driver installation interface, and enter into manual installation interface.
6. Please select installation language and printer model.

7. Select "Wireless network connection" and click on "Install".

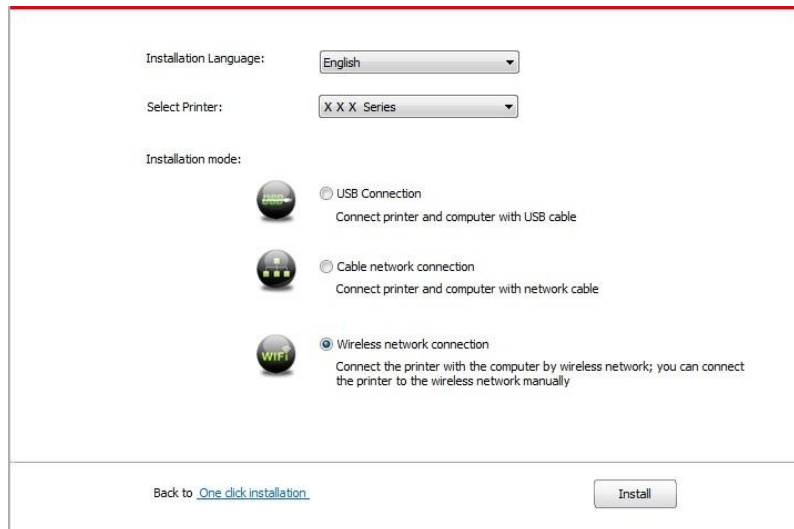

The screenshot shows a software installation window with the following elements:

- Installation Language:** A dropdown menu set to "English".
- Select Printer:** A dropdown menu set to "X X X Series".
- Installation mode:** Three radio button options:
 - USB Connection: Connect printer and computer with USB cable.
 - Cable network connection: Connect printer and computer with network cable.
 - Wireless network connection: Connect the printer with the computer by wireless network; you can connect the printer to the wireless network manually.
- Navigation:** A link "Back to [One click installation](#)" and an "Install" button.

8. Select "No, the printer has been connected to wireless network" on the wireless setup window popping out, and then click "Next".

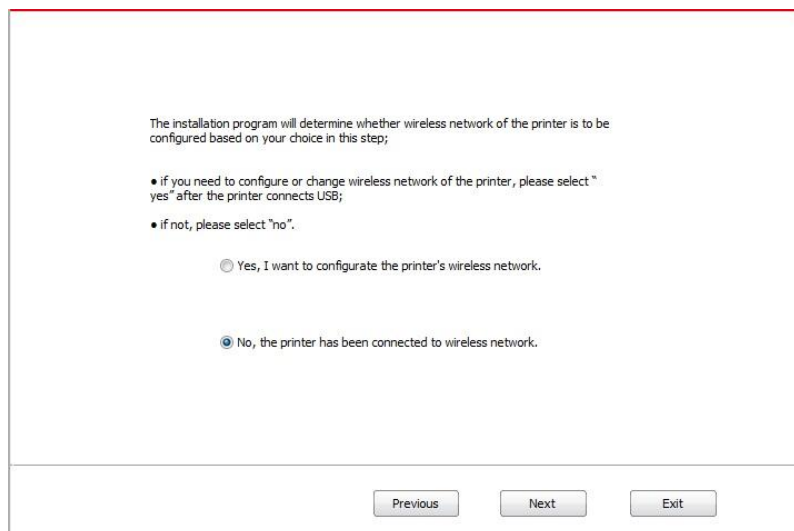

The screenshot shows a wireless setup window with the following elements:

- Text:** "The installation program will determine whether wireless network of the printer is to be configured based on your choice in this step;"
- Instructions:**
 - if you need to configure or change wireless network of the printer, please select "yes" after the printer connects USB;
 - if not, please select "no".
- Radio Buttons:**
 - Yes, I want to configurate the printer's wireless network.
 - No, the printer has been connected to wireless network.
- Navigation:** "Previous", "Next", and "Exit" buttons.

9. The installation software will search the printer automatically and the searching process may need some time.

10. Select the printer needs to be connected and click “Next”.

Printer Name	IP Address	Host name
<input checked="" type="checkbox"/> X X X Series PCL6 0001	10.10.148.140	X X X -779888

Install the printer from the list with a hostname

Add the IP address or hostname manually

 **Note:** • If the printer you need to connect is not in the list of printers searched, please click “Refresh” to search again.

- When the printer IP address changes under printer driver installed with host ID , you can also directly print without re-installing the driver. If you need to install the printer driver with the host ID, please check the option "Install the printer in the list with host ID".
 - If IP address or host name is added manually, you need to know the IP address of the printer connected or host name. If they are not made clear, please print the “NetConf Pg” and view “IP Address” and “Host name” (Please refer to [Chapter 9.1.1.3](#)).
-

11. The software installs the driver automatically and the installation process may need some time. The duration is related to your computer configuration, please wait patiently.

12. After the installation, click "Print & Test Page" button. If your printer prints the test page successfully, it means that you have installed the driver correctly.

3.1.3. Method of driver unistallation

Windows 7 is taken as the example in the following operation. The information on your computer screen may differ because of multiple operating systems.

1. Click the Start menu of computer and then click All programs.
2. Click Pantum, and then Click Pantum XXX Series.

Pantum XXX Series where XXX represents product model.

3. Click uninstall to delete the driver according to instructions on uninstall window.
4. Restart computer after finishing unloading.

3.2. macOS system driver installation

- Driver installation under Mac system is divided into 2 steps, driver installation and adding a printer.
- When you are installing a driver with wired or wireless network, you may need to know the Bonjour name of printer. Please print the “Network setup page” to view it. (Please refer to [Chapter 9.1.1.3](#)).

3.2.1. Driver installation

macOS 10.15 is taken as the example in the following operation. The information on your computer screen may differ because of multiple operating systems.

1. Turn the power of printer and computer on.
2. Insert the CD accompanying with printer in the CD driver of your computer, and double click Pantum XXX Series installation package. (**XXX** in Pantum XXX Series represents product model.)



3. Click “Continue”.

4. Читайте лицензионное соглашение, и кликните “Продолжить”.

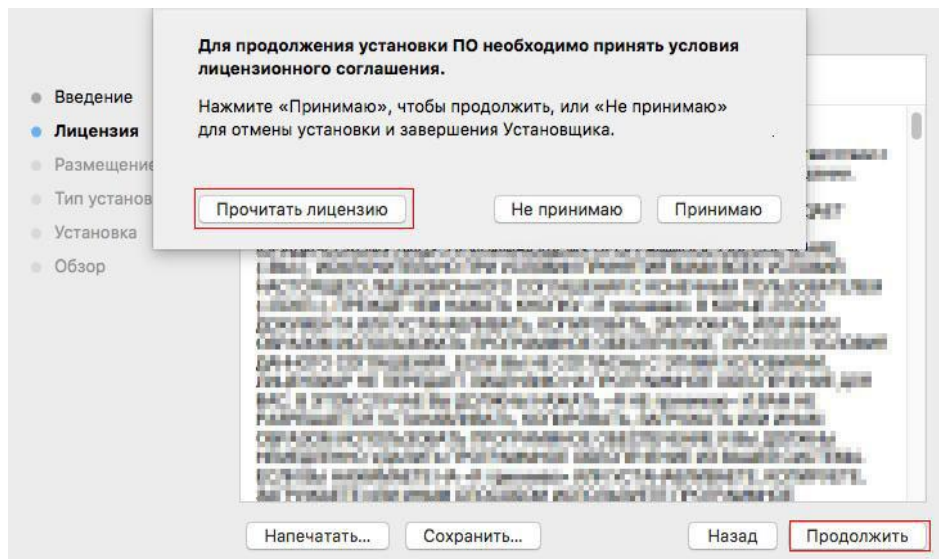

5. Кликните “Принимаю” в выталкивающем окне советования, принимай лицензионное соглашение.

6. Ознакомьтесь с Политикой конфиденциальности и нажмите «Продолжить».

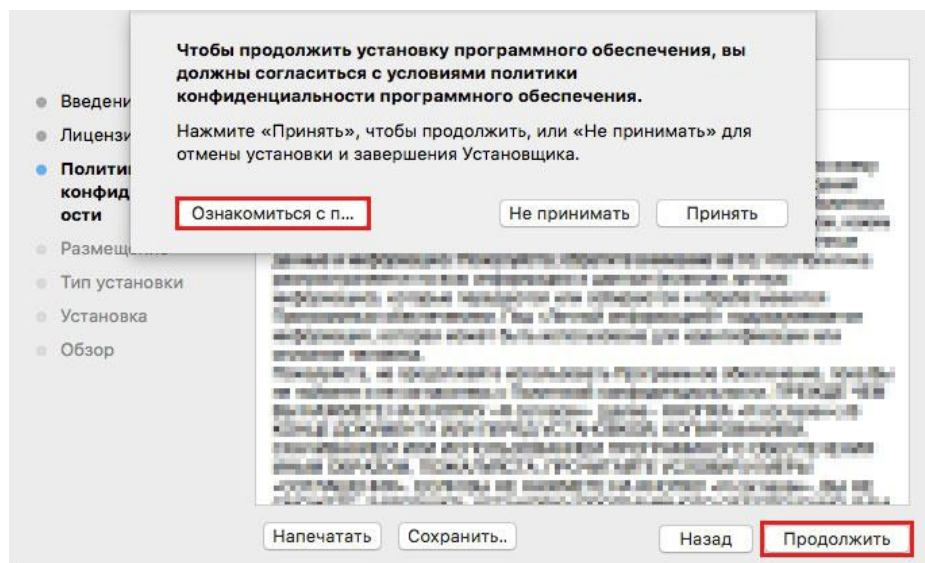

7. Чтобы принять Политику конфиденциальности, нажмите «Согласен» во всплывающем окне с подсказкой.

8. Кликните “Установить”.

9. Вводи шифр компьютера, кликните “ Установить ПО ”.

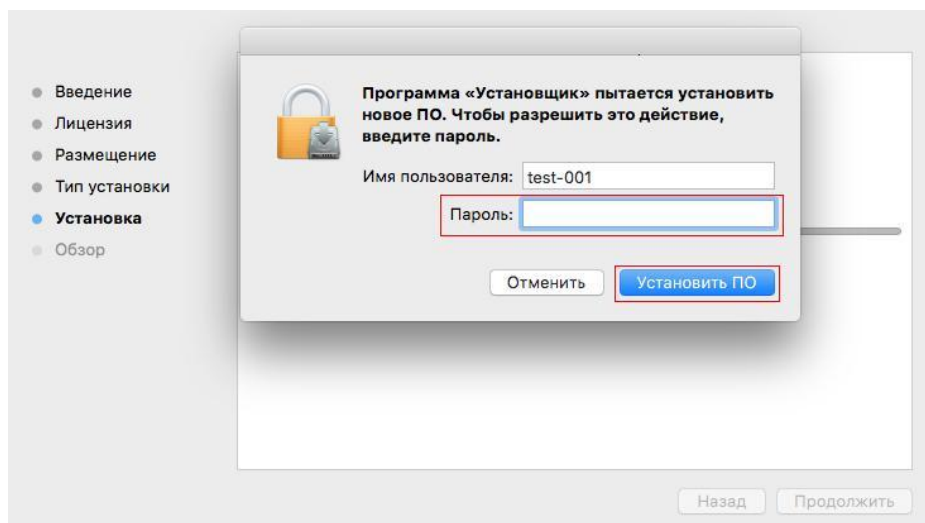

10. Кликните на “продолжение установки” в всплывающем окне.

11. Система совершит подключение программы автоматически.

• Используйте кабель USB для подключения компьютера к модулю WiFi, в процессе установке драйвера появится окно подсказки по конфигурации беспроводной сети, как показано на следующих рисунках.

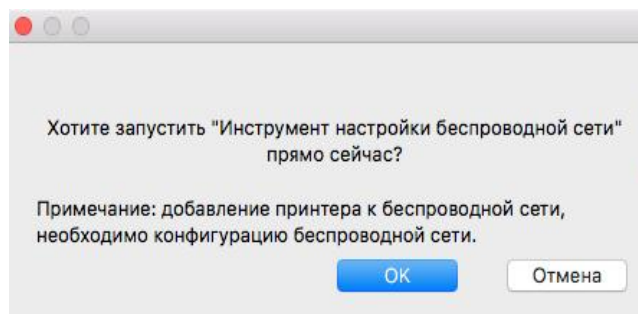

 **Note:** • Click “Yes”, you can configure printer’s wireless network via wireless network configuration tool (refer to [Chapter 5.1.1](#) for how to make configuration).When configuration is completed, unplug USB cable, and then on the pop-up “Add Printer” interface, you may add the network-connected printer(refer to [Chapter 3.3](#) for how to add printer).

• Click “No”, you can add a USB-connected printer on the pop-up “Add Printer” interface (refer to [Chapter 3.3](#) for how to add printer).

If using a USB cable to connect a computer with a non-WiFi model printer, a “Add Printer” interface will pop up during the driver installation and you can add a printer here (refer to [Chapter 3.3](#) for how to add printer).

3.3. Add printer to Mac system

3.3.1. Add up the printer via USB

1. Connect the printer to computer with USB cable and then turn power on.
2. Enter the “System Preferences” – “Printers & Scanners” of computer.
3. Click  button to select “Add Printer or Scanner”.
4. Select printer and then select the corresponding printer mode from the “Use” menu popping out.
5. Click “Add”.

3.3.2. Add up the printer via wireline connection

1. Turn the power of printer and computer on.
2. Connect the computer to wired network.
3. Connect the network cable to the network interface of printer, and make sure the printer is connected to the computer network (Please refer to [Chapter 4](#) for network setup).
4. Enter the “System Preferences” – “Printers & Scanners” of computer.
5. Click  button to select “Add Printer or Scanner”.
6. Select printer and then select the corresponding printer mode from the “Use” menu popping out.
7. Click “Add”.

3.3.3. Add up the printer via wireless connection

1. Turn the power of printer and computer on.
2. Make sure the wireless network connection between computer and printer is set up.



Note:• In case of basic structure mode, connect wireless network printer to the access point (wireless router). Please refer to [Chapter 5.1](#) for connection method.

- In case of WiFi Direct mode, connect wireless client to wireless network printer directly. Please refer to [Chapter 5.2](#) for connection methods.
-

3. Enter the “System Preferences” – “Printers & Scanners” of computer.
4. Click  button to select “Add Printer or Scanner”.
5. Select printer and then select the corresponding printer mode from the “Use” menu popping out.
6. Click “Add”.

4. Wired network setup (applicable to wired network models)

In case printers support wired network printing, they can be connected to network to control printer to print in wired network mode.

4.1. Set IP Address

The IP address of the printer may be automatically obtained through DHCP function or set manually.

4.1.1. Automatic Setting

DHCP automatic setting function is enabled by default on the printer.

1. Connect the printer to the network through a network cable and complete the startup preparation work.
2. The printer will receive the IP address assigned by server automatically. It may take server minutes to receive IP address under the influence of network environment.

You can check the printer IP address through the "Info Page" (Please see "[Chapter 9.1.1.3](#)" for printing method). If the IP address is not listed, please check the network environment or wait several minutes and try again.



Note:• If DHCP server fails to assign IP address automatically, the printer will get the link-local address assigned by printer automatically: 169.25xxx.xxx.

4.1.2. Manual Setting

To set up IP address for printer through the embedded Web server manually, please refer to [Chapter 6.2.1.2](#) for details.

5. Wireless network setup (applicable to WiFi models)

Based on models, printer models with WiFi printing function can support basic structure mode and WiFi Direct mode. If you have problems with wireless network setup, please refer to [Chapter 5.3](#) Wireless Network Setup FAQs.

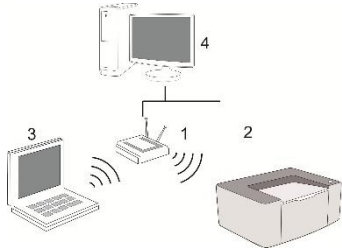
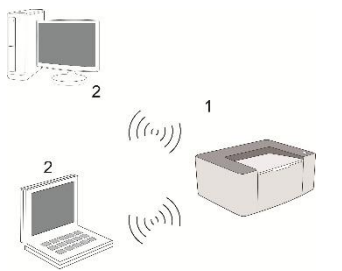
	<p>Basic structure mode: connecting to a wireless device via router</p> <ol style="list-style-type: none">1. Access point (wireless router)2. Wireless network printer3. Computer connecting to access point via wireless network4. Computer connecting to access point via network cable
	<p>WiFi Direct mode: wireless client is connecting to a printer with WiFi function</p> <ol style="list-style-type: none">1. Wireless network printer2. Wireless client is directly connecting to a wireless network printer

5.1. Basic structure mode

You can connect a computer to your printer via access point (wireless router) as the medium. For access point (wireless router) connection, the wireless network configuration tool can be used.

Important: Before wireless network installation, you must learn about the service set identifier (SSID) and password of your access point in order to use them during wireless network setup. If they cannot be determined, please consult your network administrator or access point (wireless router) manufacturer.

5.1.1. Wireless network setup tools

If your computer has been installed with a driver and had been connected to wireless network, but the wireless network was changed, you can set it again with wireless network setup tools.

5.1.1.1. Preliminary preparations

1. Access point (wireless router).
2. A computer that has been connected to network.
3. A printer that has wireless network function.

5.1.1.2. Setup methods of wireless network setup tools

1. Take the wireless network setup tool in computer.

1) **Windows system:** Click the “Start menu” – “All programs” - “Pantum” – Product name – “Wireless network setup tool”.

2) **macOS system:** click "Go" - "Applications" - "Pantum" - "Utilities" - "Wireless Network Configuration Tool" on the computer Finder menu bar.

2. Use USB cable to connect and configure. Select "Yes, I have an USB cable that can be used for installation" in the following interface. Click "Next".

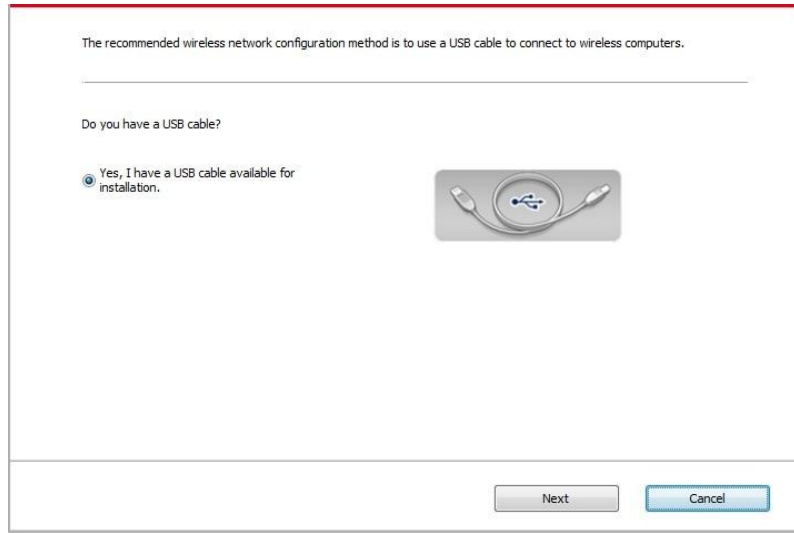

2.1 The computer has been connected to wireless network.

1) The currently wireless network currently connected to computer is selected as wireless network configuration tool by default. Complete configuration according to interface prompt.

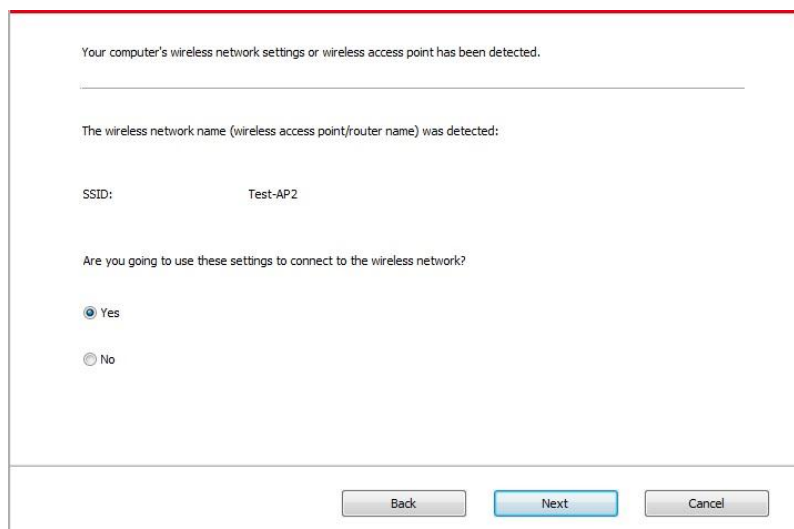

Note: • The SSID you selected should be consistent with the SSID of access point (wireless router) connected to your computer.

2) Please tick “No” to configure other wireless network needed to connect to. Complete configuration according to interface prompt.

Please select the corresponding network name (SSID) from the following list, or manually enter the SSID and password if necessary, and then click "Next" to configure.

Network Name	Encryption method	Signal Strength
Test-AP2	WPA/WPA2	100%
Test-AP3	WPA/WPA2	100%

Refresh

Network Name (SSID):
Test-AP3

Encryption method:
WPA/WPA2

Password:
 Show password

Back Next Cancel



Note: • At present, the printer supports 3 types of safe modes: none, WEP and WPA/WPA2.

1) None: There is no encryption method used.

2) WEP: Send and receive data via security key by using WEP (Wired Equivalent Privacy). WEP key is applicable to 64-digit and 128-digit encrypted network and can contain numbers and letters at the same time.

3) WPA/WPA2: it is the pre-shared key (PSK) of WiFi protected access which connects wireless device and access point via TKIP or AES encryption (WPS-Personal). The working length of WPA/WPA2 is within the PSK of 8-63 characters.

• The display password is not ticked by default; if it is ticked, all passwords input can be seen in clear text.

2.2 The computer is not connected to wireless network Input the SSID (case sensitive) and password of access point (wireless router) in the interface below. Complete configuration according to interface prompt.

1. Please click on "Print wireless network information page" to get the network name and encryption method. Please skip this step if you already know the network name and encryption method.

Printing wireless network information page

2. Please enter wireless network user name and password.

Network Name (SSID):

Encryption method:

None

Back Next Cancel



-
- Note:**
- If you do not know the SSID of access point (wireless router), please click "Print Wireless Network Information Page" to view the SSID of the needed access point (wireless router).
 - If the printer cannot be used normally after wireless network setup is finished, please install the drive again.
-

5.1.2. How to disable the WiFi network connected

Please complete the wireless network connection in infrastructure mode according to above steps. If connected, the WiFi indicator on the status control panel will be always on; now if you want to disconnect it, please press and hold this key for more than 2 seconds (the WiFi indicator will be off).

5.2. WiFi Direct mode

You can connect wireless client (including the computer and mobile device with wireless network feature) to wireless network printer without using the access point (wireless router).

5.2.1. Preliminary preparations

1. Printer with the WiFi Direct feature.
2. Wireless client (including computer and mobile device with wireless network feature).

5.2.2. WiFi Direct connection

1. Turn on printer power.

2. Enable the printer's "WiFi Direct" mode. Enabling method: short press the "WiFi" button on the printer panel and enable it.



Note: • Short press "WiFi" button on the printer panel to automatically print out "Mobile Device WiFi Connection Wizard" page for WiFi connection by mobile devices.

- Log in the embedded Web server and enable the "WiFi Direct" function. Please see [Chapter 6.2.1.3](#).

3. Turn on the computer or mobile device with wireless network function; select the SSID of WiFi Direct and input password to connect.

5.2.3. How to disable the WiFi Direct

Log in the embedded Web server (Please see [Chapter 6.1](#) for login method). Click "Settings" - "Wireless Settings" - "WiFi Direct" and set the WiFi Direct mode to "OFF" to disable the WiFi Direct function.

5.3. Wireless network setup FAQs

1. The printer is not found.

- If the power of computer, access point (wireless router) or printer is turned on.
- If the computer is connected to printer with USB cable.
- If the printer supports wireless network connection.

2. SSID cannot be found when network is connected

- Inspect if the power switch of access point (wireless router) is turned on.
- The printer cannot find the SSID of the access point (wireless router) you need to connect, please check the SSID of access point and try to connect again.
- Every time when the setup of access point (wireless router) is changed, you must set up the wireless network of printer again.

3. Connection failure

- Please inspect if the safe mode and password of access point (wireless router) and printer is correct.
- Inspect the wireless receiving around printer. Signal receiving may be affected if the router is away from the printer or there is an obstacle between them.
- Turn the power of access point (wireless router) and printer off and then restart them and set up.

4. The following aspects should be inspected if the printer has problems while they are used in network:

- Inspect if the firewall software blocks communication. If the computer and printer are connected in the same network but they cannot be searched, the communication might be blocked by firewall

software. Please refer to the user guide of firewall software to turn firewall off and then try to search the printer again.

- Inspect if the IP address assignment of printer is correct. You can inspect IP address by printing the network setup information page of printer out.

- Please refer to the following steps to check if printer and computer are in the same network:

- 1) Select "Command prompt" as shown below.

- a. Windows 8/10 system: Select "Search" button in the Start Menu and input "Command prompt" in search bar, then press the "Enter" button in the keyboard.

- b. Windows 7/Vista/XP system: click "Start" menu-"All procedures"-"Attachment"-"Command prompt".

- 2) Input ping and your printer IP address in popup window, and press "Enter" button.

For example: ping XXX.XXX.XXX.XXX("XXX.XXX.XXX.XXX" is printer IP address)

- 3) If RTT is indicated in the window, that is to say your printer and computer are in the same network. If RTT is not indicated in the window, please refer to [Chapter 5](#) to re-configure the printer wireless network.



Note: • Please refer to the user guide or consult the manufacturer for information related to access point (wireless router).

6. Web server (Applicable to network printers)

You can manage printer setup via the embedded Web server.

6.1. Visit the embedded Web server

1. Turn on the power of printer and computer.
2. Connect the printer to network to ensure that the printer is connected to the network where the computer is connected to (please refer to [Chapter 4](#) or [Chapter 5](#) for network setup method).
3. Input the IP address of printer in the address bar of Web browser to visit the Web server imbedded in printer.

Press and hold the control panel button of the printer to print "Info Page" and check the printer's "IP Address".



Note: • Windows users are suggested to use Microsoft Internet Explorer 8.0 (or higher version) or Firefox 1.0 (or higher version), Mac users are suggested to use Safari 4.0 (or higher version). No matter what kind of browser you are suing, please ensure that JavaScript and Cookies are always enabled. Please ensure compatibility with HTTP 1.0 and HTTP 1.1 when other network browsers are used.

- If the computer cannot visit the Web server embedded in printer, then your computer and printer may be connected to different networks. Please inspect your network environment or consult your network administrator.

4. Click "Log in" option, input user name and password (the default user name is admin and the initial password is 000000) and click "Log in".



Note: • For safety reasons, you are suggested to change the default password, which can be finished in the "User Management" interface.

6.2. Use Web server to manage printer

You can use the embedded Web server to manage printer.

1. View the basic information including product name, printer state and ink cartridge of printer.
2. Set up the network protocol parameters supported by printer.
3. Set up the wireless network connection of printer, and turn on/off wireless network and WiFi Direct function.
4. Set up mail server client and acquire printer state via E-mail notification.

6.2.1. Wireless setup

You can set the printer's wireless network, wireless IP configuration and WiFi Direct through the Wireless Settings page. Before setting, please log in the embedded Web Server (Please see [Chapter 6.1](#) for login method).

6.2.1.1. Wireless network

1) If you need to set up wireless network, please click the SSID of access point (wireless router) in search list, input secret key and click "Apply".

6.2.1.2. Wireless IP setup

You can set the printer's IPv4 and IPv6 through the "Wireless IP Settings" page. Before setting, please connect your printer to the internet and log in the embedded Web Server (Please see [Chapter 6.1](#) for login method). Only when the wireless network of printer is turned on, the Wireless IP Configuration can be displayed on Web server.

1) DHCPv4 is ticked by default. If IP address needs to be set up manually, please cancel the DHCPv4 checkbox ticked and input the "IPv4 Address", "Subnet Mask" and "Gateway Address" that you need to set up and then click "Apply".

6.2.1.2.1. IPv4 setup

IPv4 address of the printer is divided into DHCP auto assignment and manual setting, and the DHCP auto assignment function is on by default. You can set up the IPv4 address of printer manually to set up fixed IPv4 address for the printer.

6.2.1.2.2. IPv6 setup

In the "Wireless Network IPv6", you can check "IPv6 Local Link Address" and "Stateless address".



Note: The printer supports using the following IPv6 addresses for network printing and management.

- IPv6 local-link address: local IPv6 address set up by oneself (addresses beginning with FE80).
 - Stateless address: IPv6 address set up by network router automatically.
-

6.2.1.3. WiFi Direct setup

The printer can be connected to a wireless device via WiFi direct connection only when the printer's WiFi Direct function is enabled.

1. Click "Settings" – "Network settings" – "Wireless setup" – "WiFi Direct".

1) By default, WiFi Direct is disabled. To enable it, please select "Automatic" or "Manual" and click "Apply".

6.2.2. Sleep time setup

If you want to change the sleep time of the printer, you can set it via the embedded Web server (the printer installed via network connection).

1. Log in the embedded Web server (please refer to [Chapter 6.1](#) for login method).
2. Click “Settings” – “Machine settings” – “System”.
3. Select sleep time according to you need and then click “Apply”.

6.2.3. Recover factory settings via Web server

1. Log in the embedded Web server (please refer to [Chapter 6.1](#) for login method).
2. Click "User Management" and input the correct “User name” and “Password”; then, click “Restore to Factory Settings”. After completion, the printer will reboot automatically.









Note: • After factory settings of printer are recovered, user name of the administrator will be recovered to admin and the login password will be recovered to 000000.

7. Print

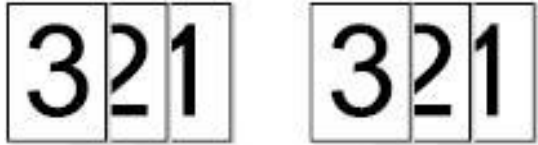
7.1. Print Function

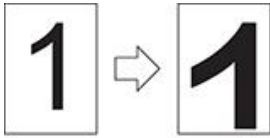
The print function can be achieved through the settings of various properties in the Printing Preferences, and some of the functions are as follows.

Functions	Diagram
Manual duplex print	
Collate	
Reverse Print	
N-in-1	
Poster Print (for Windows system only)	
Zoom Print	
Custom Size	



Note: • You can select the 2 x 2 Poster Print in N-in-1 to enable the poster printing function.

- You can enable printing preference and click the help button to view detailed function description. Please refer to [Chapter 7.2.3](#) for the method to open help document.

7.2. Print Settings

7.2.1. Print parameter settings

You can set up printing parameters with the following two methods before sending printing work (such as paper type, paper size and paper source).

Operating system	Temporary printing setup change	Permanent default setup change
Windows 7	1. Click “File” menu – “Print” – “Select printer” - “Printer properties” (the detailed steps may differ because of multiple operating systems).	1. Click “Start” menu- “Control Panel” – “Devices and Printers”. 2. Right click on the printer icon, select “Printing preference” and then change setup and save it.
macOS	1. Click “File” menu – “Print”. 2. Change setup in the window popping out.	1. Click “File” menu – “Print”. 2. Change setup in the window popping out and click to save the preset. (Select preset every time before printing, or print according to default setup.)



Note: • Priority of App setup is senior to printer setup.

7.2.2. Manual duplex print

1. The drive program of this device supports Manual Duplex Print.



Note: • If the paper is thin, it may wrinkle.

- If the paper is curled, make it flat and put it back into the automatic tray.
- If the Manual Duplex Print function causes a paper jam, please see [Chapter 11.1](#) for processing.

2. Before printing, please ensure that certain amount of paper is loaded into the automatic tray.

 **Note:** • For loading paper, please see [Chapter 2.2](#).

- Some paper media are not suitable for the duplex printing. Trying the duplex printing with it may damage the printer. When Paper Type is Thick or Transparency, please do not try Duplex Printing. If 2 x 2 Poster Print is checked in the Printing Preferences dialog box, Manual Duplex will not be supported.
-

3. Printing steps are as follows (for Windows system only) :

a) Open the document to be printed from the application (such as Notepad), and select Print from the File menu.

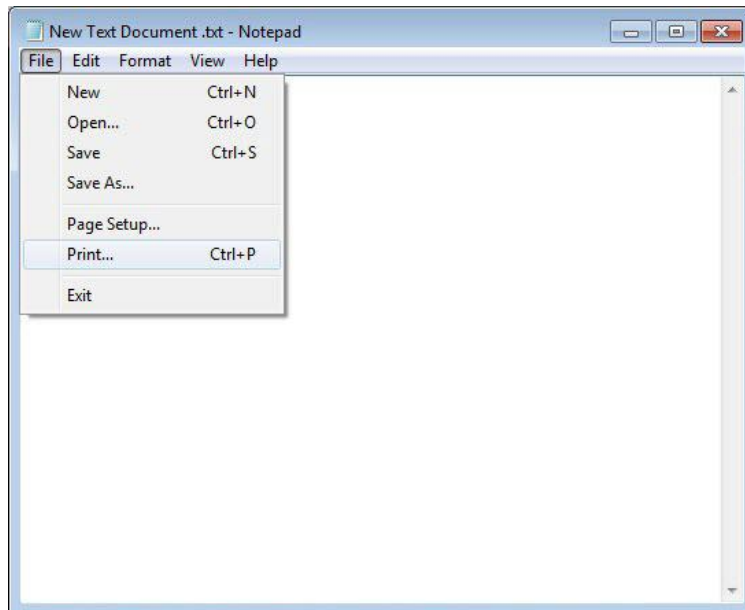

b) Select Pantum printer.

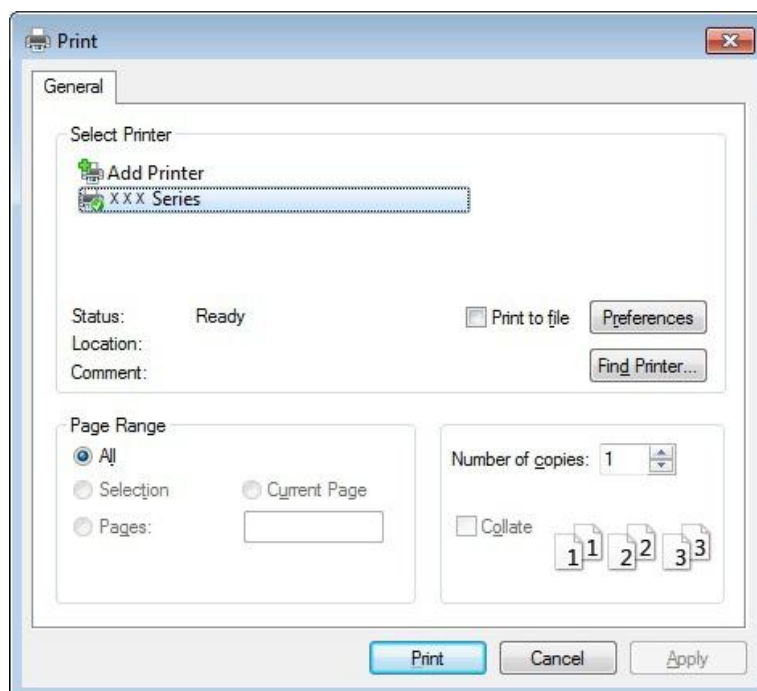

Click Preferences to set up for printing.

c) Check Manual Duplex in the Basic tab and click OK after completing the settings

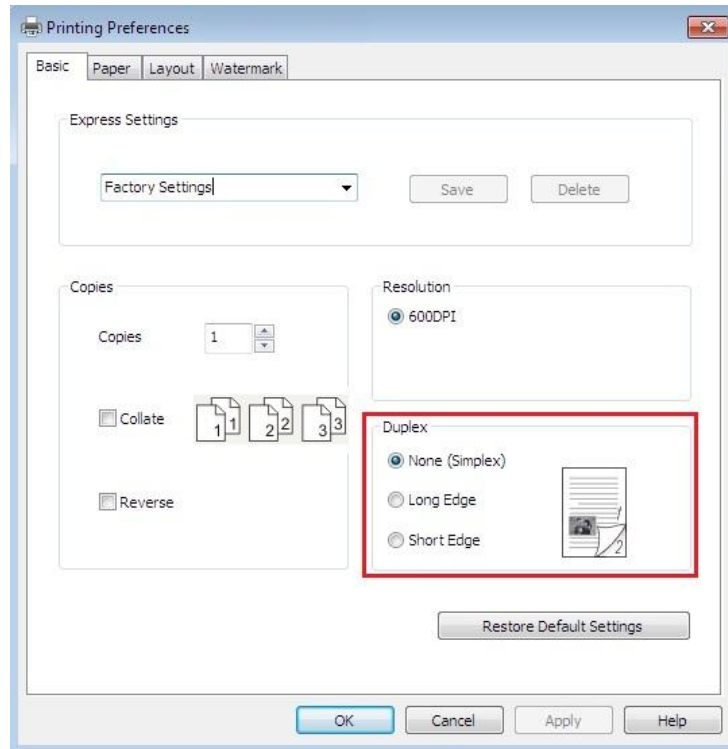

d) Click Print.

 **Note:** • It is recommended to raise the output tray to prevent the paper from sliding out of it. If you choose not to raise the output tray, we recommend that you immediately remove the printed paper output from the printer.

e) Send the print job after choosing Manual Duplex, then the following prompt window will appear, telling you the next specific operations. Interfaces are different depending on the models.

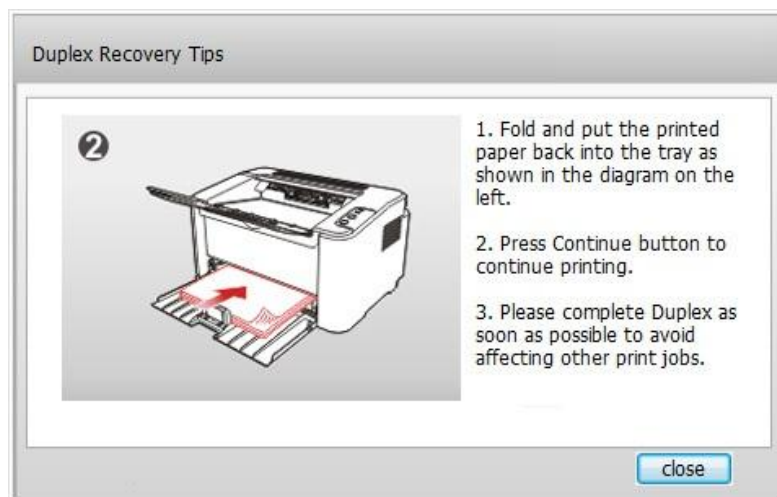

f) After turning over the paper according to the prompt, press Continue button of the printer to go on printing the other side.

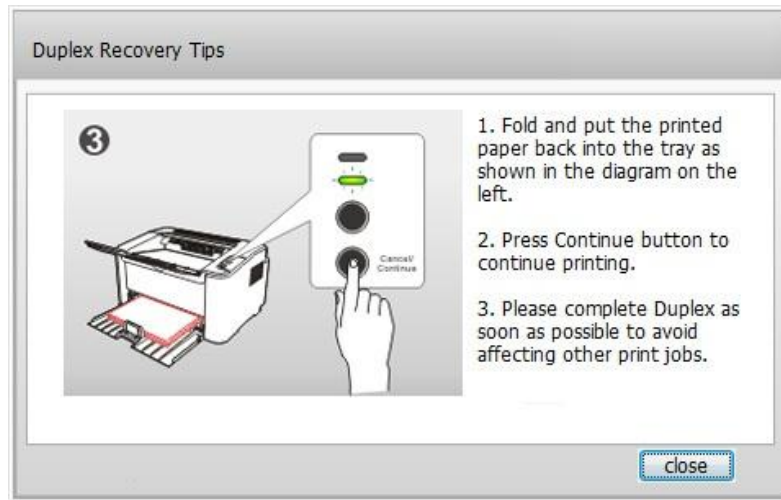

g) You can click Close button to close this prompt window, and it will not appear until the next Manual Duplex job comes in.

7.2.3. Opening Help Document

You can open the Printing Preferences and click Help button (for Windows system only). The help document contains the user guide where you can find the information on print settings.

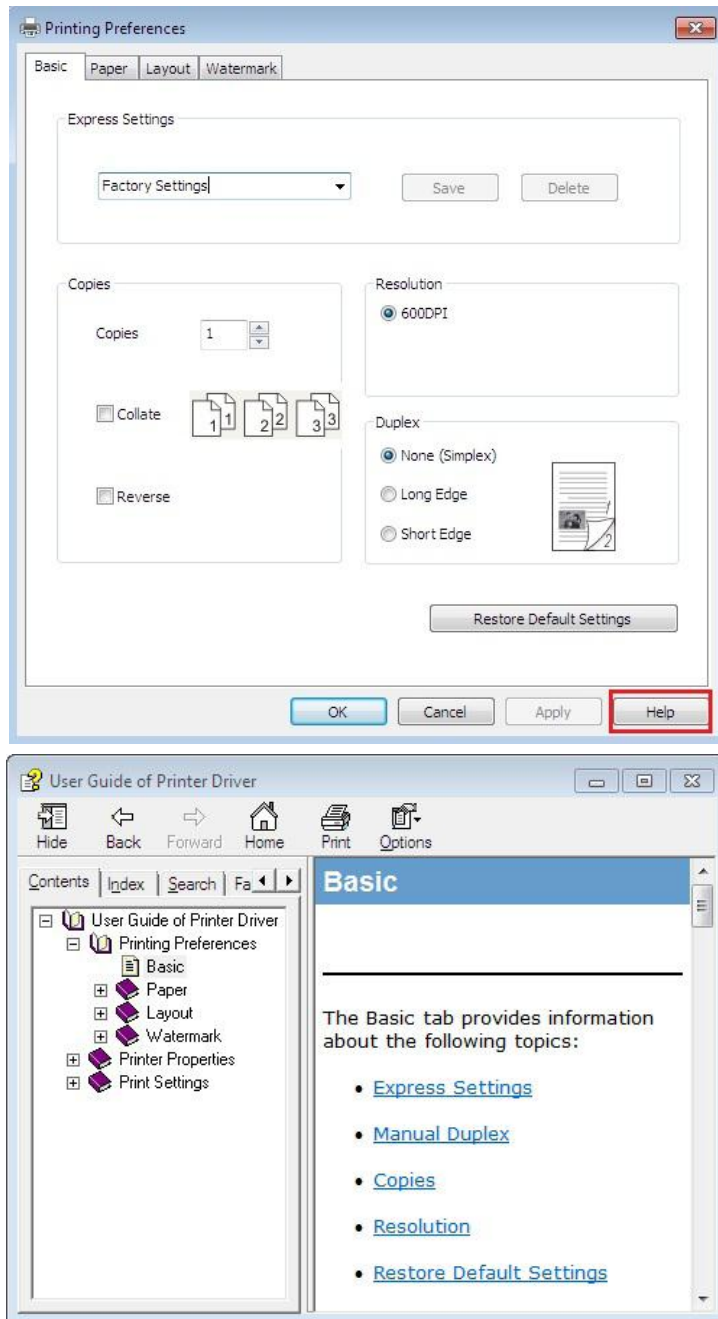

7.3. Cancel Print Job

Press and hold the Cancel/Continue button on the control panel to cancel the job you want to cancel during the printing process.

8. Mobile Print



Note: • Some functions are not available depending on different printer models. If you have any questions, please contact the Customer Service.

8.1. "Pantum" APP

Pantum APP is a free application with mobile printing, scanning and faxing functions, allowing you to print or fax photos, files, pages and scan photos or files directly from mobile terminal. Your printer may not support all of above mentioned functions, so please select relevant function of Pantum APP for use according to your printer type. Please be sure the application has been installed and connected to wireless network properly before use.

8.1.1. Operating systems supported

"Pantum App" is suitable for Android 4.4-10.0 and iOS 7.0-14.0 system versions. .

8.1.2. How to download Pantum App

You can scan the QR code on the "Mobile Device WiFi Connection Wizard" page for downloading or try the methods below for downloading:



Note: • Short press "WiFi" button on the printer control panel to print out "Mobile Device WiFi Connection Wizard" page (only applicable for WiFi models)

Download method for Android mobile device:

1. You can click "APP" in the upper right corner on the web page <http://www.pantum.com>, to view details and check, download and install the APP.

Download method for iOS mobile device:

Click the App Store icon > Search interface > input "PANTUM" or "Pantum print" in the search bar > Download and install on the interface of iOS device to download.

8.1.3. How to use this "Pantum" APP

During usage, ensure that the mobile device installed with application has been connected to the wireless network printer (Please see [Chapter 5](#) for connection method.)

8.1.3.1. For Android Devices

8.1.3.1.1. Preliminary preparations

1. A printer that has wireless network function.
2. Android mobile device.

8.1.3.1.2. Operation steps

1. Turn on printer power.
2. For an Android mobile device, tap the “PANTUM” icon on the main screen to enter the first interface of “PANTUM”.
3. Select adding method based on your usage habits to finish the adding in printer.
4. Select the function you want and then do relevant settings to meet your functional demands.



- Note:**
- If failure of operation, please check if your Android mobile device has access to the wireless network into which your printer is connected.
 - If the Android device cannot detect any printer, please inspect if power of the printer is turned on and if the printer is turned on.
 - To learn more, please see the Installation Manual.
-

8.1.3.2. For iOS Devices

8.1.3.2.1. Preliminary preparations

1. A printer that has wireless network function.
2. iOS mobile device.

8.1.3.2.2. Operation steps

1. Turn on printer power.
2. For an iOS mobile device, tap the “PANTUM” icon on the main screen to enter the first interface of “PANTUM”.
3. Select adding method based on your usage habits to finish the adding in printer.
4. Select the function you want and then do relevant settings to meet your functional demands.



- Note:**
- If printing fails, please inspect if the iOS device is connected to the wireless network where the printer is connected to.
 - If the iOS mobile device did not detect any printer, check whether the printer is powered on and the printer is turned on.
 - To learn more, please see the Installation Manual.
-

9. General Settings

This Chapter mainly introduces some general settings.

 **Note:** • The setting appearances may vary by model functions. The schematic diagram is only for reference.

9.1. Control Panel Overview

The printer control panel layout includes 2 buttons and 2 multi-colored LEDs, as shown below. The left figure is the control panel for printers with USB+ WiFi interface, and the right figure is the control panel for printers with USB interface:

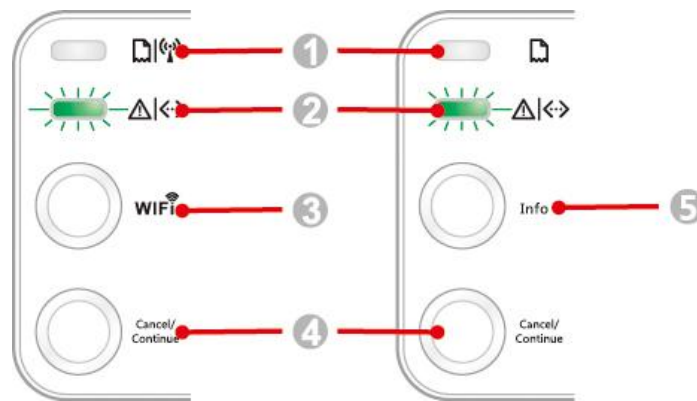

Serial No.	Name
1	Multi-colored LED1 indicator
2	Multi-colored LED2 indicator
3	WiFi search button
4	Cancel/Continue button
5	Information button

9.1.1. Functions of Buttons on the Control Panel

9.1.1.1. Operation Function of WiFi Search Button

If there is no WiFi connection, short-press this button to launch WiFi connection and search WiFi Hotspot AP; stop searching if it fails to find any Access Point (AP) within 2 minutes.

If there is WiFi connection while no WiFi print job, press and hold this button to disconnect WiFi connection.

If there is WiFi connection and WiFi print job, wait until the job is completed and then press and hold this button to disconnect the WiFi connection.

During WiFi connection, press and hold the button to cancel WiFi connection.

In Sleep Mode, press or press and hold the button to wake up the printer and exit Sleep Mode.

9.1.1.2. Operation Function of Cancel/Continue Button

If the printer is in sleep mode, press or press and hold this button can wake it up.

Press and hold this button during printing can cancel the current print job.

When the printer is in ready mode, press and hold this button can print the test page.



9.1.1.3. Operation Function of Information Button



When the printer is in ready mode, press and hold this button can print the test page.

9.1.2. Function of LED Indicators on the Control Panel

9.1.2.1. LED1 Status Indication









The meanings of the status indication of LED1 are as follows:

Serial No.	Paper/WiFi Multi-colored LED1 Status Indication	Status Description (For printers with USB+WiFi interface)	Status Description (For printers with USB interface)
1		No WiFi connection, no paper error, sleep mode LED1 off	No WiFi connection, no paper error, sleep mode LED1 off
2		Searching WiFi, no indication of paper error LED1 with green light flashing slowly	N/A
3		Successful WiFi connection, no paper error LED1 with green light staying on	N/A

4		Paper Jam Error LED1 with red light staying on	Paper Jam Error LED1 with red light staying on
5		Paper shortage in printing, or failed in feeding LED1 with red light flashing quickly	Paper shortage in printing, or failed in feeding LED1 with red light flashing quickly





















9.1.2.2. LED2 Status Indication

The meanings of the status indication of LED2 are as follows:

Serial No.	Data/Cartridge Multi-colored LED2 Status Indication	Status Description (For printers with USB+WiFi interface and the ones with USB interface only)
1		Starting and warming up the printer, waking up and warming up the printer, and warming up the printer by opening and closing its cover. LED2 with green light flashing slowly
2		The printer is ready LED2 with green light staying on
3		Sleep LED2 with green light on and flashing slowly
4		Printing Multi-colored LED2 with green light flashing quickly
5		Alarming for toner low LED2 with orange light on and flashing quickly
6		Cartridge error (not installed, mismatch, expired) LED2 with orange light staying on
7		Serious printer error (heating roller abnormalities, laser motor abnormalities, communication error, opened cover, etc.) LED2 with red light staying on
8		A job is cancelled via the panel LED2 with light flashing quickly

9.1.2.3. Indication of LED1 and LED2 Combination Status

You can refer to the indicator combination list for information on the working status of the printer. Some of the LED1 and LED2 combined indications are as follows:

Serial No.	Status		Status Description
	Paper/WiFi (Multi-colored LED1)	Data/Cartridge (Multi-colored LED2)	
1			Paper jam, the printer is ready LED1 with red light staying on, LED2 off
2			Paper jam during printing LED1 with red light staying on, multi-colored LED2 off
3			Paper jam, alarming for toner low LED1 with red light staying on, LED2 off
4			Paper jam, cartridge error (not installed, mismatch, expired) LED1 with red light staying on, LED2 off
5			Paper jam, serious printer error (heating roller abnormalities, laser motor abnormalities, communication error, opened cover, etc.) LED1 off, LED2 with red light staying on
6			Paper jam, a job is cancelled via the panel LED1 off, LED2 with green light flashing quickly
7			Paper shortage in printing, or failed in feeding, only showing paper errors LED1 with red light flashing quickly, LED2 off
8			Paper shortage in printing, or failed in feeding, alarming for toner low LED1 with red light flashing quickly, LED2 off
9			Paper shortage in printing, or failed in feeding, cartridge error (not installed, mismatch, expired) LED1 off, LED2 with orange light staying on
10			Paper shortage in printing, or failed in feeding, and meanwhile, serious printer error (heat roller abnormalities, laser motor abnormalities, communication error, opened cover, etc.) LED1 off, LED2 with red light staying on



A job is being cancelled via the panel because of paper shortage in printing or failure in feeding
LED1 with green light off, LED2 with green light flashing quickly

9.2. System Setting

Windows 7 is taken as the example in the following operation. The information on your computer screen may differ because of multiple operating systems.

9.2.1. Sleep Time Setting

Sleep mode can reduce the energy consumption of printer effectively, and "Sleep time setting" can be made in the idle time before the device enters sleep mode.

Operation steps are as follows (suitable for printers installed via USB connection):

1. Enter the "Start menu" – "Control Panel" –view "Devices and Printers".
2. Right click printer and select "Printer properties" in the pull-down menu.
3. Enter the "Secondary Settings" option.
4. Select the sleep time to be set in "Sleep Time Setting". Click "Confirm/Apply" to finish settings.

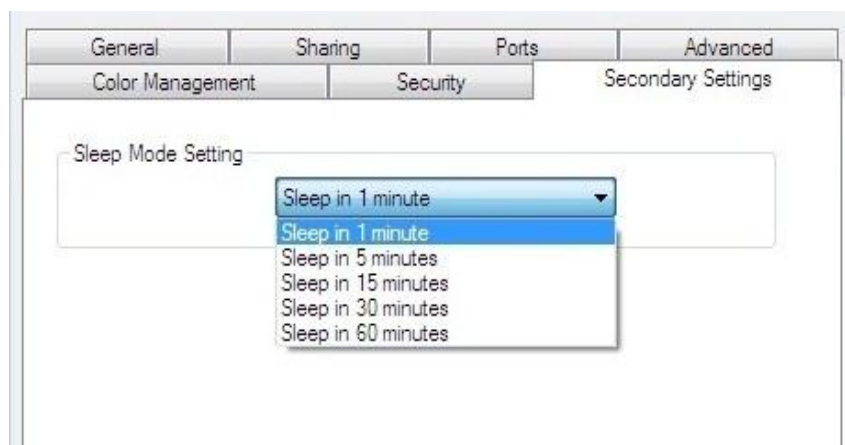

Note: • When the printer is in sleep mode, you can press any button or send printing job to wake it up.

9.3. Restore Factory Settings

To reset all parameter settings of products, you can conduct Restore Factory Settings. Specific steps: when the product power supply is turned off, press and hold "Cancel/Continue" button. Power on the product until two LEDs flash orange simultaneously. Release the button until the printer is back to Ready status to finish resetting.

9.4. Consumable information

You can check consumable information through the Printing Info page on the printer control panel (Please see [Chapter 9.1.1.3](#) for printing method of Printing Info page.)

10. Routine Maintenance

10.1. Cleaning the Printer

 **Note:** • Please use mild detergents.

Please clean the printer in accordance with the following steps:

1. Turn off the main power switch and unplug the power cord and USB cable.

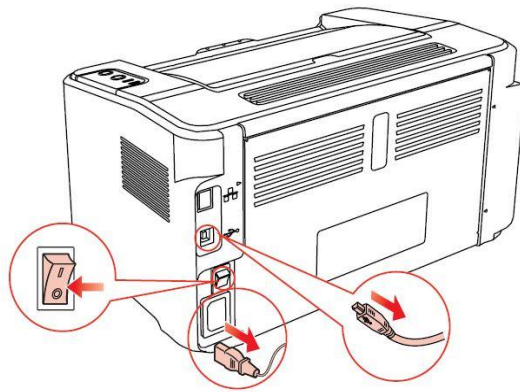

2. Use a soft cloth to wipe the outside of the printer clean.

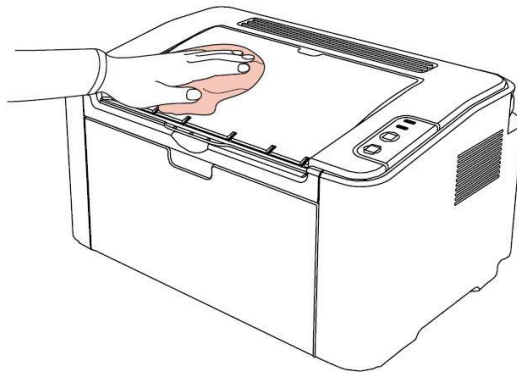

3. Open the upper cover and take out the laser toner cartridge.

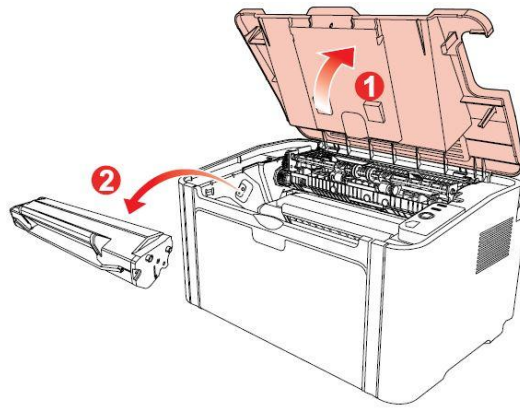

 **Note:** • When removing the laser toner cartridge, put the cartridge in a protective bag or wrap it with thick paper to avoid direct light damaging the photosensitive drum.

4. Clean the inside of the printer by using a dry and lint-free cloth to gently wipe the shaded area as shown in the figure below.

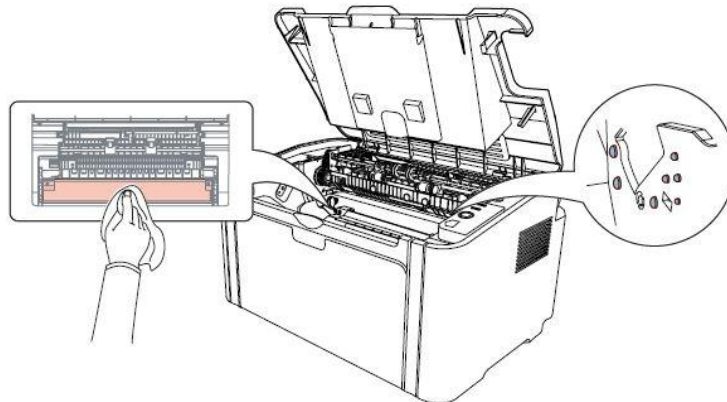

10.2. Maintenance of Laser Toner Cartridge

10.2.1. Use and Maintenance of Laser Toner Cartridge

For better print quality, please use the original Pantum laser toner cartridge.



Note: when using the laser toner cartridge, please pay attention to the following:

- Unless used immediately, otherwise, do not remove the laser toner cartridge from the package.

Do not attempt to refill the laser toner cartridge without authorization. Otherwise, the resulting damage is not included in the printer warranty.

- Please store the laser toner cartridge under a cool and dry environment.
 - Toner inside the laser toner cartridge is combustible. Please do not put the laser toner cartridge near any source of ignition, so as to avoid causing a fire.
 - When removing or disassembling the laser toner cartridge, please pay attention to the toner leakage problem. In case of the toner leakage resulting in that the toner contacts with your skin or splashes into your eyes and mouth, please immediately wash with clear water, and consult a doctor immediately if you feel unwell.
 - When placing the laser toner cartridge, please keep it away from the area reachable by children.
-

10.2.2. Service Life of Laser Toner Cartridge

Service life of the laser toner cartridge depends on the amount of toner that print jobs require.

When the printer LED indicator shows the status in the following figure, it indicates that the laser toner cartridge life has expired and needs to be replaced.

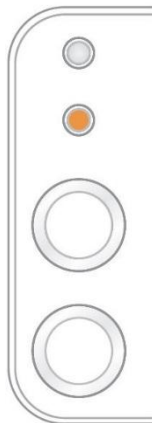

10.2.3. Replace Laser Toner Cartridge

 **Note:** before replacing the laser toner cartridge, please pay attention to the following:

- The laser toner cartridge surface may contain toner. Please remove it carefully to avoid spilling.
 - Put the removed laser toner cartridge on a piece of paper to avoid the toner from accidentally spilling.
 - After removing the protective cover, please immediately install the laser toner cartridge into the printer, so as to avoid photosensitive drum damage caused by exposing to too much direct sunlight or indoor light.
 - While installing the laser toner cartridge, do not touch the surface of the photosensitive drum so as not to scratch it.
-

Replacement steps are as follows:

1. Open the upper cover, and remove the empty laser toner cartridge along the guides.

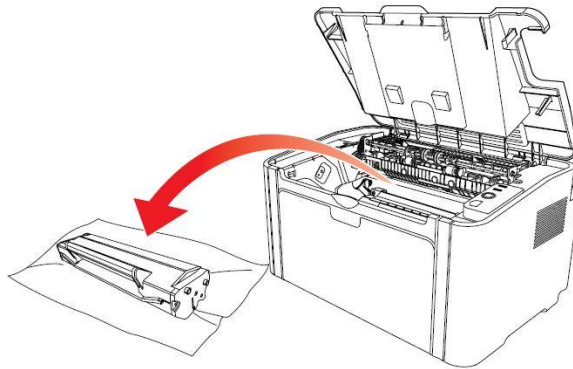

2. Open the package of a new laser toner cartridge, hold the handle of the cartridge and gently shake around 5-6 times, so as to make the toner evenly distributed inside the cartridge.

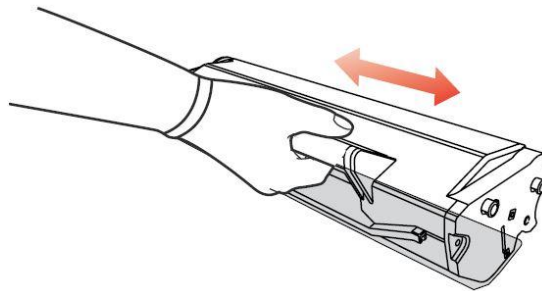

3. Remove the protective cover, and put the laser toner cartridge into the printer along the guides.

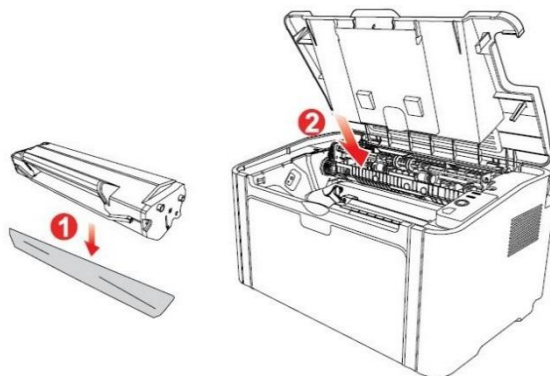

 **Note:** • Check whether there is any seal on it before installing the laser toner cartridge into the printer; if there is any, please tear off the seal and then install the cartridge.

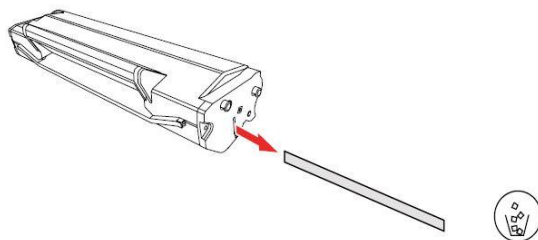

4. Close the upper cover tightly.

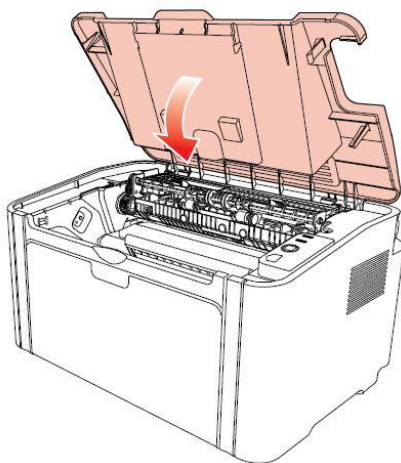

11. Troubleshooting

Please read this section carefully. It can help you solve common trouble in the printing process. If the problems appeared cannot be solved, please contact Pantum Aftersales Service Center.

Prior to handling common trouble, first check that:

- The power cord is connected correctly and the printer is powered on.
- All of the protective parts are removed.
- The laser toner cartridge is correctly installed.
- The output bin is fully closed.
- The paper is correctly loaded into the tray.
- The interface cable is correctly connected between the printer and the computer.
- The correct printer driver is selected and installed properly.
- The computer port is properly configured and is connected to the proper printer port.

11.1. Clearing Jammed Paper



Note: Remove the jammed paper in accordance with the following steps, close the upper cover and tidy the paper in the tray, then the printer will automatically resume printing. If the printer cannot automatically start printing, please press the button on the control panel.

- If the printer still does not start printing, please check whether all the jammed paper inside the printer are cleared.
 - If you cannot remove the jammed paper yourself, please contact your local Pantum authorized repair center or send the printer to the nearest Pantum authorized service center for repair.
-

11.1.1. Paper Jam in the Feed Port

If the output tray is open, please close it at first.

Gently pull the jammed paper straight out.

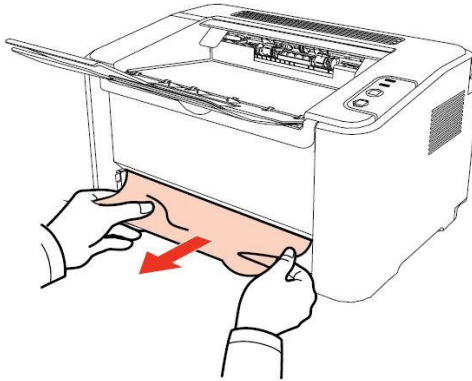

If the paper does not move while being pulled, or there is no paper in this area, please check the inside of the printer.

11.1.2. Paper Jam inside the Printer

1. Open the upper cover.

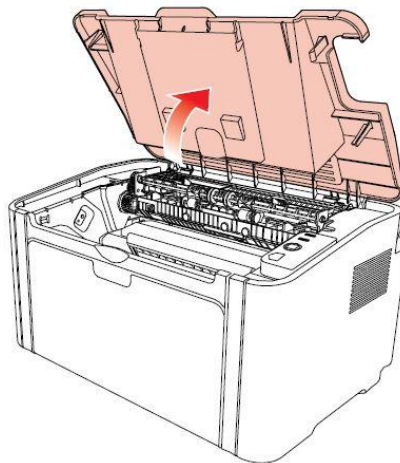

2. Open the upper fuser guide to decrease the pressure of compression spring.

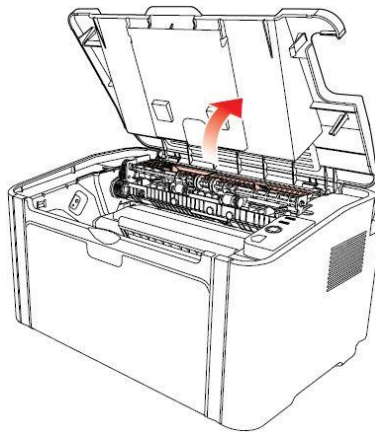

3. Pull the jammed paper out of the fuser unit.

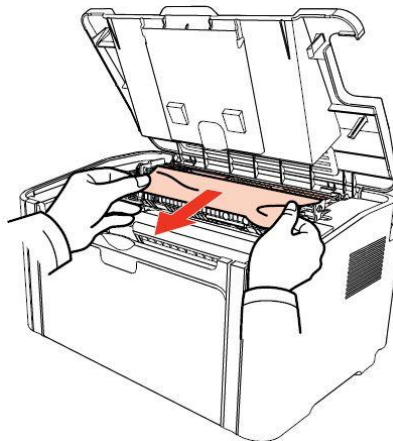

If no jammed paper is found, please go to the next step.

4. Remove the laser toner cartridge along the guides.

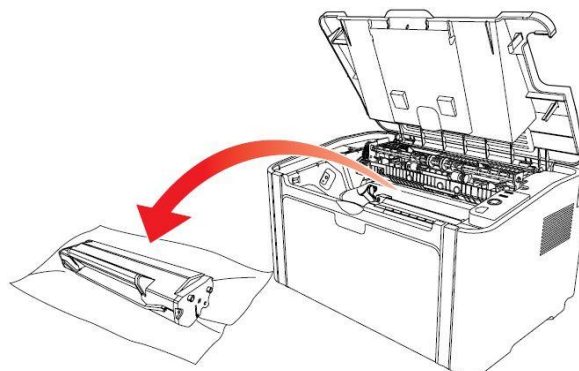

5. Slowly pull the jammed paper out along the paper output orientation.

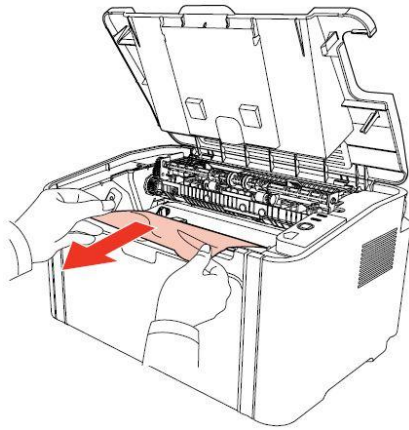

6. After removing the jammed paper, insert the laser toner cartridge into the printer along the guides until you hear a click assuring you that the cartridge is fully inserted.

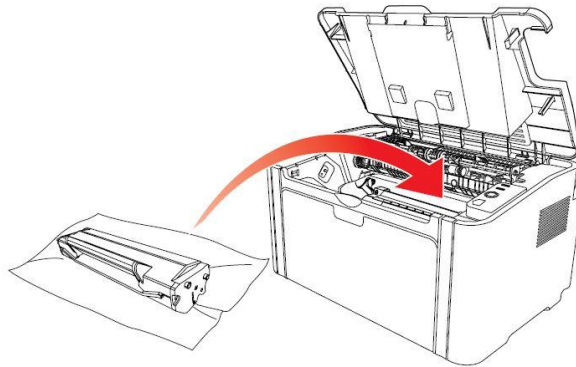

7. Neatly put the paper in the tray. Until the indicator light resumes print-ready status, proceed to the next print.

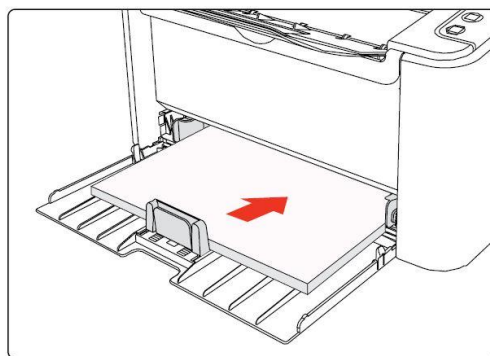

11.2. Common Troubleshooting

11.2.1. Common Trouble

Trouble	Cause	Solution
Printer Problems		
The printer does not work	<p>The cable between the computer and the printer is not connected properly.</p> <p>Error in specifying the print port.</p> <p>The printer is offline, and Use Printer Offline is checked.</p> <p>The printer does not recover from an internal error, such as a paper jam, paper empty, etc.</p>	<p>Disconnect and then reconnect the printer cable.</p> <p>Check the printer settings to ensure that the print job is sent to the correct port. If the computer has more than one port, make sure that the printer is connected to the correct port.</p> <p>Make sure that the printer is in the normal online status.</p>
Laser toner cartridge issue		
The laser toner cartridge chip cannot be detected.	<p>The laser toner cartridge chip is dirty.</p> <p>The laser toner cartridge chip contacts the spring or the copper pillar and gets dirty.</p>	<p>Please clean the laser toner cartridge chip surface.</p> <p>Please clean the contact spring or the copper pillar.</p>
Problems in Handling Paper		
Paper feed failure	<p>The print media is loaded incorrectly.</p> <p>The print media is beyond the usage specification range.</p> <p>The feed roller is dirty.</p>	<p>Please install the print media correctly.</p> <p>Please use the print media within the specification range.</p> <p>Clean the feed roller.</p>
Paper Jam	<p>There is too much paper in the tray.</p> <p>The print media is beyond the usage specification range.</p> <p>There is foreign matter in the feed channel.</p> <p>The feed roller is dirty.</p> <p>Internal parts failure.</p>	<p>Remove excess paper from the tray.</p> <p>Remove excess paper from the tray.</p> <p>Clean the feed channel.</p> <p>Clean the feed roller.</p>
Print with multipage fed in	<p>Excessive static electricity on the print media.</p> <p>The print media is damp and sticks together.</p> <p>Internal parts failure.</p>	<p>Separate the print media to eliminate some static electricity.</p> <p>It is suggested that you use the recommended print media.</p> <p>Separate the print media or use better quality and</p>

dry print media..



The vapor comes out around the paper discharge area

The heat generated during the toner fusing causes the paper to vapor (This happens even more often when you use dampened paper under low ambient temperature)

Vapor is not an abnormality in this case, but still you can use newly unpacked paper to avoid generation of vapor. Also, keep your paper from the damp. Although vapor is not an abnormality, using unopened new paper can prevent vapors. In addition, please take care of paper to prevent damping. If scorched flavor appears, please directly turn off the power and unplug the power cord. Then, consult the Customer Service Center. If this status persists, it may cause fire or electric shock.

 **Note:** • If the issue persists, please contact the Customer Service Center.

11.2.2. Image Defects

Trouble	Cause	Solution
 The printout is whitish or light	<ul style="list-style-type: none">• Toner is low.• The print media does not meet usage specification, such as the media is damp or too rough.• The resolution in the print program is set too low.• The laser toner cartridge is damaged.	<ul style="list-style-type: none">• Please properly use the print media within the specification range.• Setup the print resolution in the program.
 Toner spots	<ul style="list-style-type: none">• The laser toner cartridge is dirty or leaks toner.• The laser toner cartridge is damaged.• The print media that does not meet usage specification, such as the media is damp or too rough.• The feed channel is dirty.	<ul style="list-style-type: none">• Please use the print media within the specification range.• Clean the feed channel.
 White spots	<ul style="list-style-type: none">• The print media that does not meet usage specification, such as the media is damp or too rough.• The feed channel is dirty.• The internal part of the laser toner cartridge is damaged.• The reflective glass of the laser inside the printer is dirty.	<ul style="list-style-type: none">• Please use the print media within the specification range.• Clean the feed channel.• Clean the reflective glass of the laser.



Toner comes off

- The print media that does not meet usage specification, such as the media is damp or too rough.
- The inside of the printer is dirty.
- The laser toner cartridge is damaged.
- The internal part of the printer is damaged.
- Please use the print media within the specification range.
- Clean the inside of the printer.

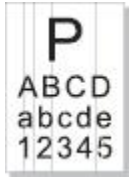

Black vertical stripes

- The laser toner cartridge is dirty.
- The internal part of the laser toner cartridge is damaged.
- The reflective glass of the laser inside the printer is dirty.
- The feed channel is dirty.
- Clean the reflective glass of the laser at the back of the printer.
- Clean the feed channel at the back of the printer.



Black background
(gray background)

- The print media that does not meet usage specification, such as the media is damp or too rough.
- The laser toner cartridge is dirty.
- The internal part of the laser toner cartridge is damaged.
- The feed channel is dirty.
- The transfer voltage inside the printer is abnormal.
- Please use the print media within the specification range.
- Clean the feed channel inside the printer.

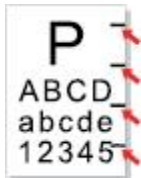

Cyclical traces
appear

- The laser toner cartridge is dirty.
- The internal part of the laser toner cartridge is damaged.
- The fuser component is damaged.
- Clean the laser toner cartridge or replace it with a new one.
- Please contact Pantum Customer Service to repair and replace the fuser component.



Skewed pages

- The print media is loaded incorrectly.
- The feed channel of the printer is dirty.
- Please install the print media correctly.
- Clean the feed channel inside the printer.



Wrinkled paper

- The print media is loaded incorrectly.
- The print media does not meet the usage specification.
- The feed channel inside the printer is dirty.
- The fuser component of the printer is damaged.
- Please install the print media correctly.
- Please use the print media within the specification range for printing.
- Clean the feed channel inside the printer.



The back of the printout is dirty

- The laser toner cartridge is dirty.
- The transfer roller inside the printer is dirty.
- The transfer voltage inside the printer is abnormal.
- Clean the laser toner cartridge or replace it with a new one.
- Clean the internal transfer components of the printer.



Whole page dark

- The laser toner cartridge is installed incorrectly.
- The internal part of the laser toner cartridge is damaged.
- Abnormal charge inside the printer; the laser toner cartridge is not charged.
- Ensure to install the cartridge correctly.



The toner does not adhere to the paper

- The print media that does not meet usage specification, such as the media is damp or too rough.
- The inside of the printer is dirty.
- The laser toner cartridge is damaged.
- The internal part of the printer is damaged.
- Please use the print media within the specification range.
- Clean the inside of the printer.

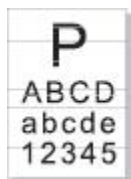

Horizontal stripes

- The laser toner cartridge is incorrectly installed.
- The laser toner cartridge might be damaged.
- The internal part of the printer is damaged.
- Ensure to install the cartridge correctly.



Note: • Failures above can be improved by cleaning or replacing toner cartridge. Please contact customer services center if the problem can still not be solved.

12. Product Specification

-  **Note:** • Specification values vary slightly from printers with different models with different functions, and product specifications vary from different countries and regions.
- These values are based on the initial data. For more information about the latest specifications, please visit: www.pantum.com.

12.1. Specification Overview

Product Size (W*D*H)	337mm*220mm*178mm
Product weight (excluding the cartridge)	4kg
Print Environment	Optimal Printing Temp Range: 10-32°C
	Relative humidity range: 20%~80%RH
Power Voltage	220V Model: AC220~240V,50Hz/60Hz,3A
Noise (acoustic pressure level)	Print: 52dB(A)
	Standby: 30dB(A)
Enter network standby time:	1 minutes
Power Consumption	Printing: average 370W
	Ready: 38W
	Sleep: <2W
Operating System	Microsoft Windows XP/ Windows Vista/Windows 7/Windows 8/Windows 8.1/ Windows 10/ Windows Server2003/2008/2012 (32/64Bit)
	macOS 10.7/10.8/10.9/10.10/10.11/10.12/10.13/10.14/10.15
	Linux(Ubuntu 12.04~18.04)
	iOS 7.0-14.0
	Android 4.4-10.0
Communication interface	USB 2.0(High Speed)
	IEEE802.11b/g/n interface

12.2. Print Specifications

Print Speed	Please see Chapter 1.1 .
Print Time of First Page	≤7.8S
Print Language	GDI

Supplier's Declaration of Conformity

47 CFR § 2.1077 Compliance Information

Unique Identifier

Trade Name: PANTUM

Model No.: P221**/P251**(* could be A-Z, a-z, 0-9 or blank)

Responsible Party – U.S. Contact Information

Company Name: PANTUM (USA) CO.,LTD

Office address:13875 Ramona Ave.,Chino, CA 91710

TEL: 626-965-6662

FCC Compliance Statement

This device complies with Part 15 of the FCC Rules. Operation is subject to the following two conditions:

(1) This device may not cause harmful interference, and (2) this device must accept any interference received, including interference that may cause undesired operation.

USA Only

PANTUM